



Mike Holt's Illustrated Guide To

Article 680

SWIMMING POOLS, HOT TUBS, AND FOUNTAINS

Extracted from Understanding the National Electrical Code® Volume 2



This document is protected under copyright law. For permission to share this work, please contact Info@MikeHolt.com



Mike Holt Enterprises
MikeHolt.com • 888.632.2633

BASED ON THE
2023
NEC®

NOTICE TO THE READER

The publisher does not warrant or guarantee any of the products described herein or perform any independent analysis in connection with any of the product information contained herein. The publisher does not assume, and expressly disclaims, any obligation to obtain and include information other than that provided to it by the manufacturer.

The reader is expressly warned to consider and adopt all safety precautions that might be indicated by the activities herein and to avoid all potential hazards. By following the instructions contained herein, the reader willingly assumes all risks in connection with such instructions.

The publisher makes no representation or warranties of any kind, including but not limited to, the warranties of fitness for particular purpose or merchantability, nor are any such representations implied with respect to the material set forth herein, and the publisher takes no responsibility with respect to such material. The publisher shall not be liable for any special, consequential, or exemplary damages resulting, in whole or part, from the reader's use of, or reliance upon, this material.

Author: Mike Holt

Technical Illustrator: Mike Culbreath

COPYRIGHT © 2023 Charles Michael Holt



Produced and Printed in the USA

All rights reserved. No part of this work covered by the copyright hereon may be reproduced or used in any form or by any means graphic, electronic, or mechanical, including photocopying, recording, taping, or information storage and retrieval systems without the written permission of the publisher. You can request permission to use material from this text by either calling 888.632.2633, e-mailing Info@MikeHolt.com, or visiting www.MikeHolt.com.

For more information, call 888.NEC.CODE (632.2633), or e-mail Info@MikeHolt.com.

NEC®, NFPA 70®, NFPA 70E® and National Electrical Code® are registered trademarks of the National Fire Protection Association.



This logo is a registered trademark of Mike Holt Enterprises, Inc.

ABOUT THE AUTHOR

Mike Holt is an author, businessman, educator, speaker, publisher and *NEC*® expert. He has written hundreds of electrical training books and articles, founded three successful businesses, and has taught thousands of electrical *Code* seminars across the United States and internationally.

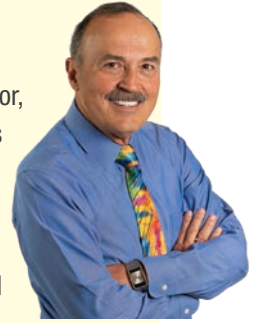

Mike's approach to electrical training is based on his own experience as an electrician, contractor, inspector and teacher. He's always felt a responsibility to his students and to the electrical industry to provide education beyond the scope of just passing an exam. This commitment, coupled with the lessons he learned at the University of Miami's MBA program, have helped him build one of the largest electrical training and publishing companies in the United States.

Mike's one-of-a-kind presentation style and his ability to simplify and clarify technical concepts explain his unique position as one of the premier educators and *Code* experts in the country. His passion for the electrical field drives his goal to increase electrical safety and improve lives.

Mike's commitment to pushing boundaries and setting high standards extends into his personal life. He's an eight-time Overall National Barefoot Waterski Champion with more than 20 gold medals, many national records, and he has competed in three World Barefoot Tournaments. In 2015, at the tender age of 64, he started a new adventure—competitive mountain bike racing. Every day he continues to find ways to motivate himself, both mentally and physically.

Mike and his wife, Linda, reside in New Mexico and Florida, and are the parents of seven children and six grandchildren. As his life has changed over the years, a few things have remained constant: his commitment to God, his love for his family, and doing what he can to change the lives of others through his products and seminars.

*I dedicate this book to the
Lord Jesus Christ,
my mentor and teacher.
Proverbs 16:3*



ADDITIONAL PRODUCTS TO HELP YOU LEARN

Understanding the NEC Complete Video Library

Do you want a comprehensive understanding of the *Code*? Then you need Mike's best-selling *Understanding the NEC Complete Video Library*. This program has helped thousands of electricians learn the *Code* because of its easy-to-use format. Mike guides students through the most utilized rules and breaks them down in a complete and thorough way. The full-color instructional graphics in the textbooks help students visualize and understand the concepts being taught; the videos provide additional reinforcement with Mike and the panel discussing each article, its meaning and its application in the real world. When you need to know the *Code*, this program is the best tool you can use to start building your knowledge—there's no other product quite like it.



LIBRARY INCLUDES:

Understanding the *National Electrical Code*, Volume 1 Textbook

- ▶ *Understanding the National Electrical Code Volume 1 videos*

Understanding the *National Electrical Code*, Volume 2 Textbook

- ▶ *Understanding the National Electrical Code Volume 2 videos*

Understanding the *National Electrical Code* Workbook (Articles 90–480)

Bonding and Grounding Textbook

- ▶ *Bonding and Grounding videos*

Plus! Digital versions of the textbook and digital answer keys

2023 Code Books and Tabs

The easiest way to use your copy of the *NEC* correctly is to tab it for quick reference. Mike's best-selling tabs make organizing your *Code* book easy. Please note that if you're using it for an exam, you'll need to confirm with your testing authority that a tabbed *Code* book is allowed into the exam room.

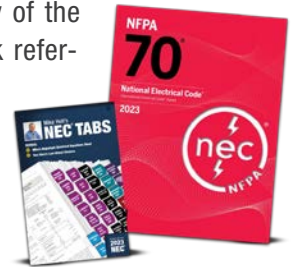

To order your *Code* book and tabs, visit MikeHolt.com/Code.

ARTICLE 680

SWIMMING POOLS, HOT TUBS, AND FOUNTAINS

Introduction to Article 680—Swimming Pools, Hot Tubs, and Fountains

This article covers the installation of electrical wiring and equipment for swimming pools, hot tubs, spas, fountains, and hydromassage bathtubs. It is divided into eight parts which only apply to certain types of installations. Be very careful to determine which part(s) of this article apply as identified in the “General” section of each part so you can correctly apply the rules. Many of these rules are outside of the scope of this material, however, some of the topics we cover include the following:

- ▶ Bonding and Grounding
- ▶ Underwater Pool Luminaires
- ▶ Pool Light Junction Boxes, Transformers, or GFCI Enclosures
- ▶ Equipotential Bonding
- ▶ Hot Tubs
- ▶ Fountains

Article 680 consists of eight parts:

- ▶ Part I. General Requirements for Pools, Spas, Hot Tubs, and Fountains
- ▶ Part II. Permanently Installed Pools
- ▶ Part III. Storable Pools
- ▶ Part IV. Hot Tubs
- ▶ Part V. Fountains
- ▶ Part VI. Therapeutic Pools and Tubs (not covered)
- ▶ Part VII. Hydromassage Bathtubs
- ▶ Part VIII. Electrically Powered Pool Lifts (not covered)



►Figure 680-2

According to Article 100, a “Pool” is defined as a manufactured or field-constructed equipment designed to contain water on a permanent or semipermanent basis and used for swimming, wading, immersion, or other purposes [680]. ►Figure 680-3

Part I. General Requirements for Pools, Spas, Hot Tubs, and Fountains

680.1 Scope

Article 680 covers the installation of electric wiring and equipment for swimming pools, hot tubs, spas, fountains, and hydromassage bathtubs.

►Figure 680-1 and ►Figure 680-2



►Figure 680-3



►Figure 680-1

Author’s Comment:

- The definition of a pool includes baptisteries (immersion pools) which must comply with the requirements of Article 680.
- An above ground pool having a maximum water depth greater than 42 in. is considered a permanent pool. See the definition of ‘storable pool.’

According to Article 100, a “Spa or Hot Tub” is a recreational or therapeutic hydromassage tub typically not drained after each use (Article 680). ▶Figure 680-4

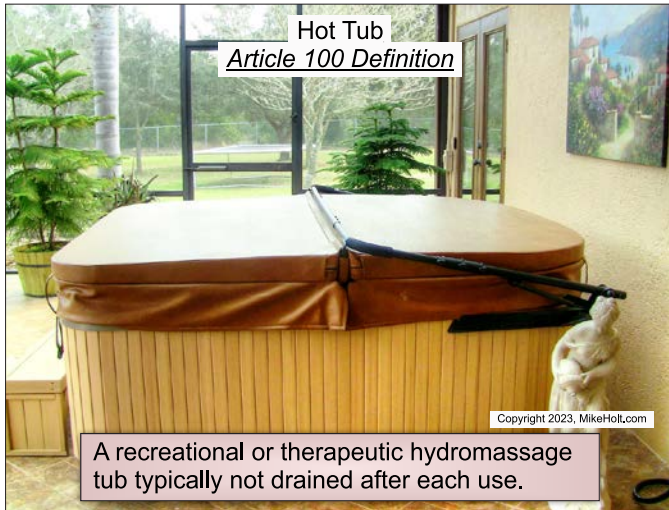

▶Figure 680-4

According to Article 100, a “Fountain” is defined as an ornamental structure or recreational water feature from which one or more jets or streams of water are discharged into the air including splash pads, ornamental pools, display pools, and reflection pools. This definition does not include drinking water fountains or water coolers (Article 680).

▶Figure 680-5



▶Figure 680-5

680.4 Inspections After Installation

The authority having jurisdiction is permitted to require periodic inspection and testing for swimming pools and similar bodies of water.

680.5 GFCI and SPGFCI Protection

(A) General. The GFCI and SPGFCI requirements in this Article are in addition to the requirements in 210.8.

(B) GFCI Protection. Where ground fault protection is required in this article for branch circuits rated 150V or less to ground and 60A or less, a GFCI device must be used.

According to Article 100, a “Ground-Fault Circuit Interrupter (GFCI)” is defined as a device intended to protect people by de-energizing a circuit when ground-fault current exceeds the value established for a Class A device. ▶Figure 680-6

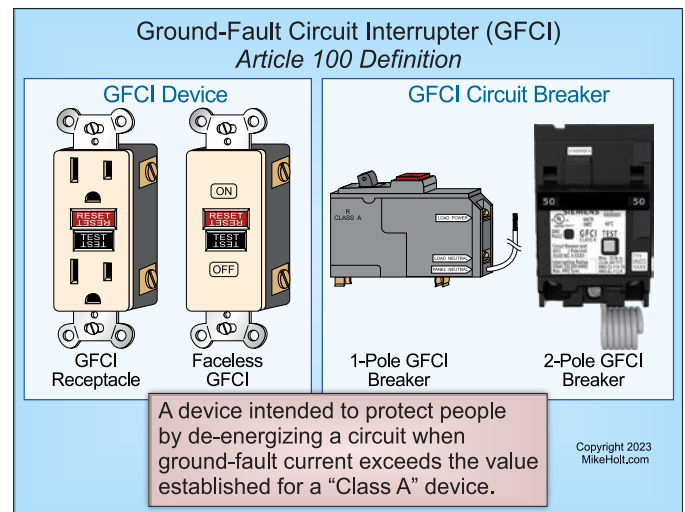

▶Figure 680-6

(C) SPGFCI Protection. Where ground-fault protection is required in this article for branch circuits rated over 150V or less to ground, a SPGFCI device must be used.

According to Article 100, a “Special Purpose, Ground-Fault Circuit Interrupter (SPGFCI)” is defined as a device intended to de-energize a 277/480V circuit when the ground-fault current exceeds the values established for a Class C device. ▶Figure 680-7

Ground-Fault Circuit Interrupter, Special Purpose (SPGFCI)
Article 100 Definition

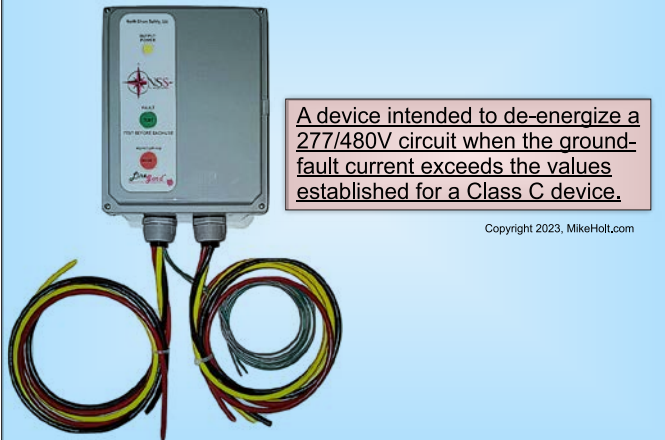

▶ Figure 680-7

Author's Comment:

- ▶ A GFCI protective device is intended to protect humans against maximum let-go levels (muscle contraction) for circuits rated not over 150V to ground, with a trip-open value of 6-mA. An SPGFCI protective device is intended to protect humans against ventricular fibrillation (electrocution) for circuits above 150V to ground, with a trip-open value of 20 mA.

680.6 Listing Requirements

Electrical equipment covered by this article is required to be listed.

▶ Figure 680-8

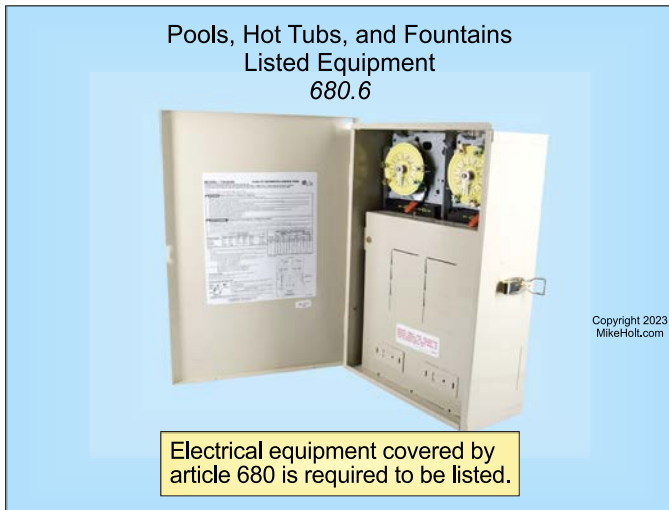

▶ Figure 680-8

680.7 Grounding and Bonding

(A) Insulated Equipment Grounding Conductor. Feeders and branch circuits located in a corrosive environment or wet location must contain an insulated copper equipment grounding conductor sized in accordance with Table 250.122, but not smaller than 12 AWG.

▶ Figure 680-9

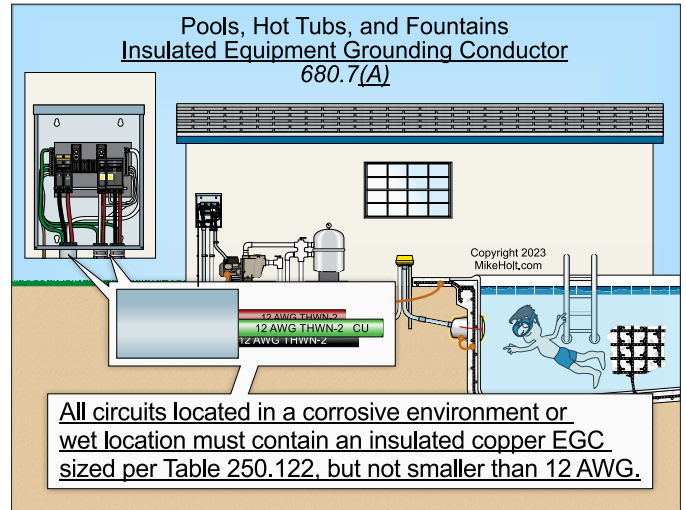

▶ Figure 680-9

According to Article 100, a “Corrosive Environment” is defined as areas or enclosures without adequate ventilation where electrical equipment is located and pool sanitation chemicals are stored, handled, or dispensed (Article 680). ▶ Figure 680-10

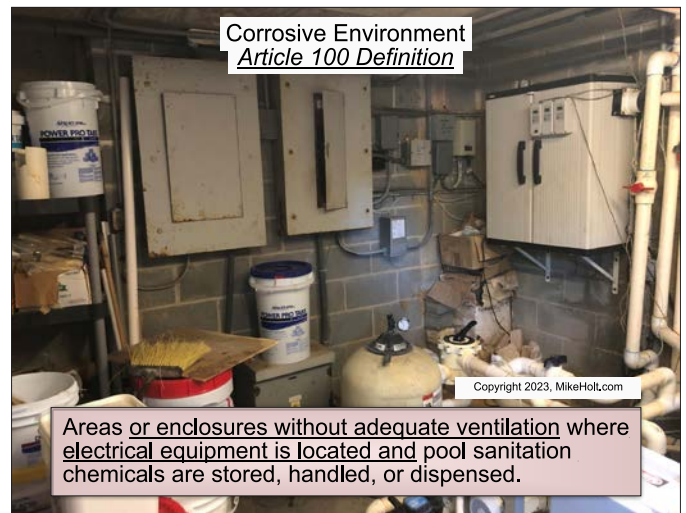

▶ Figure 680-10

Note 1: Sanitation chemicals and pool water pose a risk of corrosion (gradually damaging or destroying materials) due to the presence of oxidizers (for example, calcium hypochlorite, sodium hypochlorite, bromine, and chlorinated isocyanurates) and chlorinating agents that release chlorine when dissolved in water.

(B) Cord-and-Plug Connections. Flexible cords must contain an equipment grounding conductor that is an insulated copper conductor sized in accordance with Table 250.122, but not smaller than 12 AWG. The flexible cord must terminate in a grounding-type attachment plug having a fixed grounding contact member.

(C) Terminals. Field-installed terminals in damp or wet locations or corrosive environments must be listed for direct burial use. ▶**Figure 680-11**



▶**Figure 680-11**

680.9 Overhead Conductor Clearance

Overhead conductors must meet the clearances from the maximum water level requirements contained in Table 680.9(A). The clearance measurement is taken from the maximum water level. ▶**Figure 680-12**

According to Article 100, “Maximum Water Level,” is the highest level that water can reach before it spills out.

(A) Overhead Power Conductors. Exposed overhead power conductors cannot be installed within the clearances contained in Table 680.9(A). ▶**Figure 680-13**

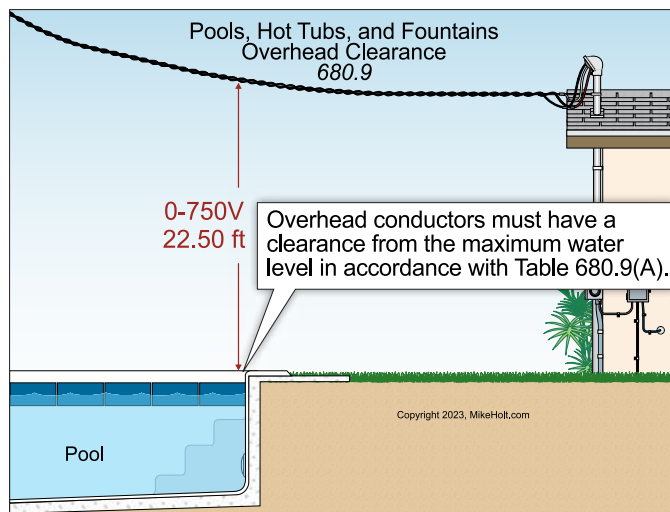

▶**Figure 680-12**

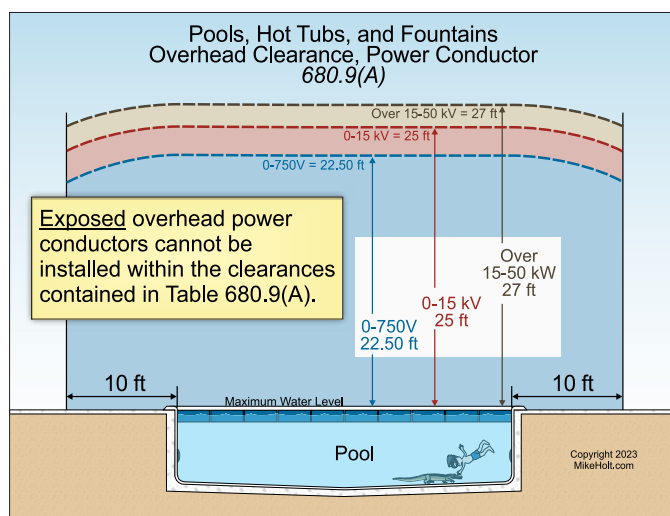

▶**Figure 680-13**

Author's Comment:

- ▶ This rule does not prohibit utility-owned overhead service-drop conductors from being installed over a pool, hot tub, or fountain [90.2(D)(5)]. However, it does prohibit a pool, hot tub, or fountain from being installed under an existing service drop that is not at least 22½ ft above the water.

(B) Communications Systems [Chapter 8]. Communications, radio, and television cables within the scope of Chapter 8 cannot be installed less than 10 ft above the maximum water level of swimming and wading pools and diving structures, observation stands, towers, or platforms. ▶**Figure 680-14**

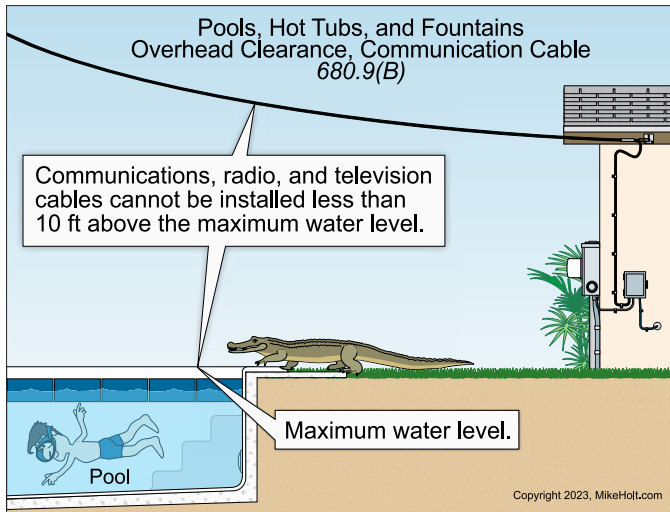

▶Figure 680-14

Author's Comment:

- ▶ This rule does not prohibit a utility-owned communications overhead cable from being installed over a pool, hot tub, or fountain [90.2(B)(4)]. It does prohibit a pool, hot tub, or fountain from being installed under an existing communications utility overhead supply that is not at least 10 ft above the water.

680.10 Electric Pool Water Heaters and Heat Pumps

(A) Water Heaters. Branch-circuits for pool water heaters must be sized at not less than 125 percent of the equipment nameplate current rating. ▶Figure 680-15

(B) Water Heat Pump. Branch-circuits for pool water heat pump heaters must be sized in accordance with the equipment nameplate current rating. ▶Figure 680-16

680.11 Underground Wiring

(A) Underground Wiring. Underground wiring methods installed complete between outlets, junctions, or splicing points within 5 ft horizontally from the inside wall of the pool must be one of the following: ▶Figure 680-17

- (1) Rigid metal conduit
- (2) Intermediate metal conduit

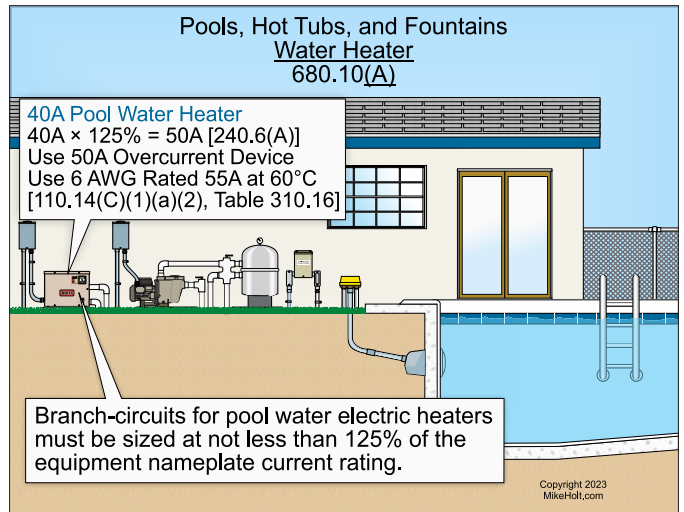

▶Figure 680-15

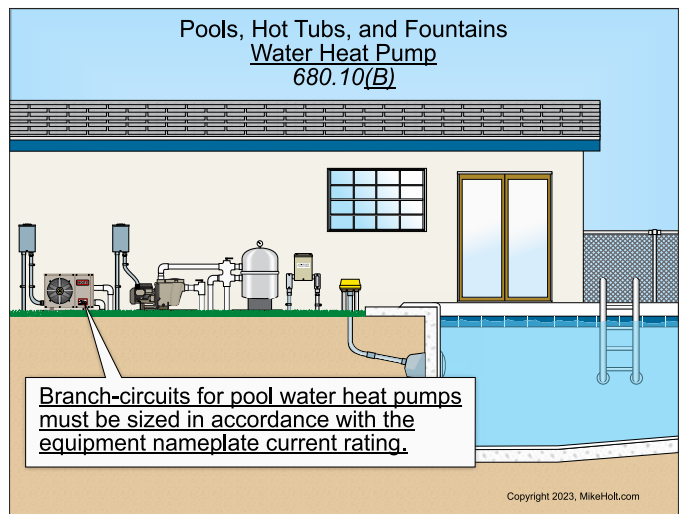

▶Figure 680-16

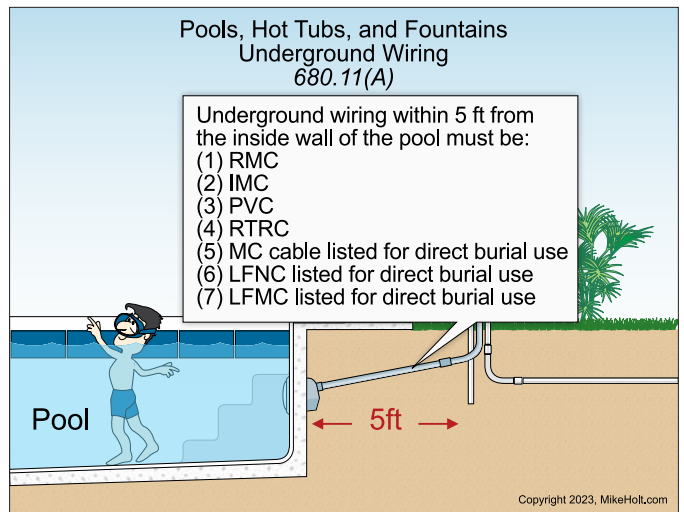

▶Figure 680-17

- (3) Rigid polyvinyl chloride conduit
- (4) Reinforced thermosetting resin conduit
- (5) Jacketed Type MC cable listed for direct burial use
- (6) Liquidtight flexible nonmetallic conduit listed for direct burial use
- (7) Liquidtight flexible metal conduit listed for direct burial use

(B) Wiring Under Pools. Underground wiring beneath pools is permitted for the supply of pool equipment permitted by this article and no other loads.

680.12 Equipment Rooms, Vaults, and Pits

(A) Drainage. Permanently installed pools, hot tubs, or fountain equipment are not permitted to be in rooms, vaults, or pits that do not have drainage that prevents water accumulation during normal operation or maintenance, unless the equipment is rated and identified for submersion.

(B) Receptacles. At least one GFCI-protected 125V, 15A or 20A receptacle must be within the equipment room for permanently installed pools, hot tubs, or fountains. ▶Figure 680-18

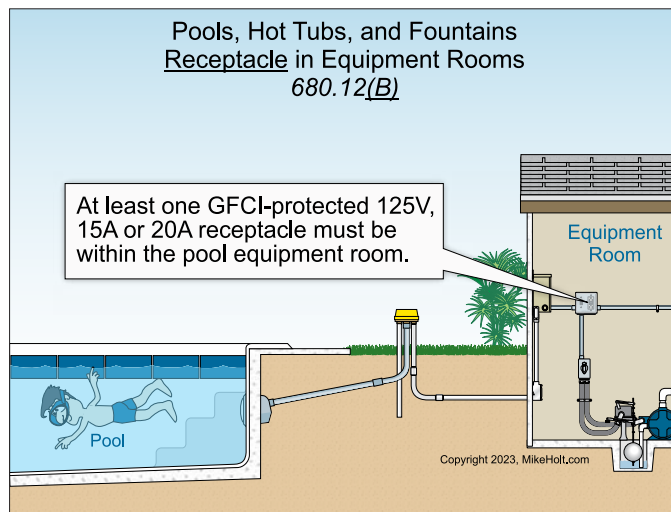

▶Figure 680-18

Receptacles supplied by branch circuits rated 150V or less to ground within an equipment room, vaults, or pits must be GFCI protected.

680.13 Equipment Disconnecting Means

A disconnect is required for pool, hot tub, or fountain equipment. The disconnect must be readily accessible and be within sight and not less than 5 ft from the pool, hot tub, or fountain water, unless separated by a permanently installed barrier. This horizontal distance is measured from the water's edge along the shortest path required to reach the disconnect. ▶Figure 680-19

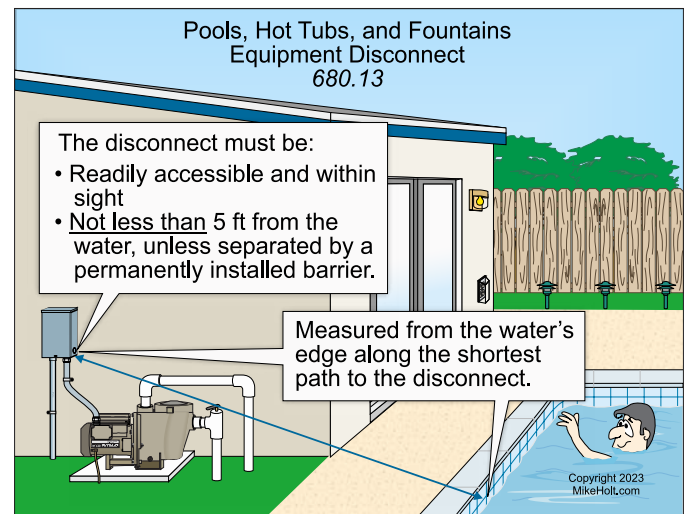

▶Figure 680-19

According to Article 100, "Within Sight" means equipment that it is visible and not more than 50 ft from the location of the other equipment. ▶Figure 680-20



Visit MikeHolt.com

Discover lots of free resources:

Code Forum | Instructor Resources | Graphics | Videos | Weekly Newsletters | & much more...

The Most Informative Electrical Resource on the Web Today

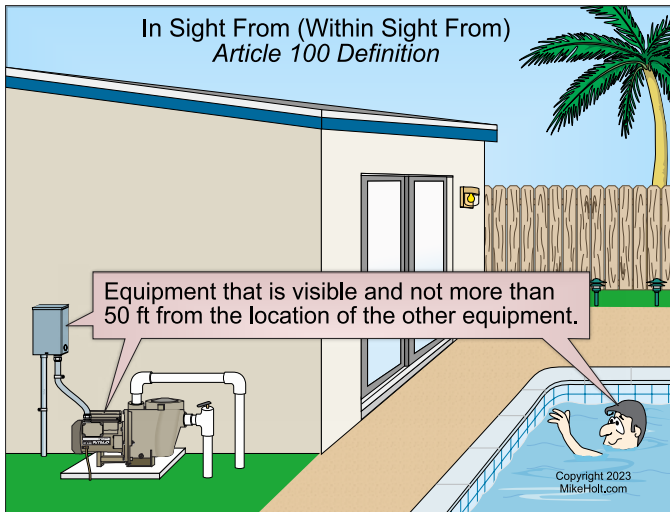

▶Figure 680-20

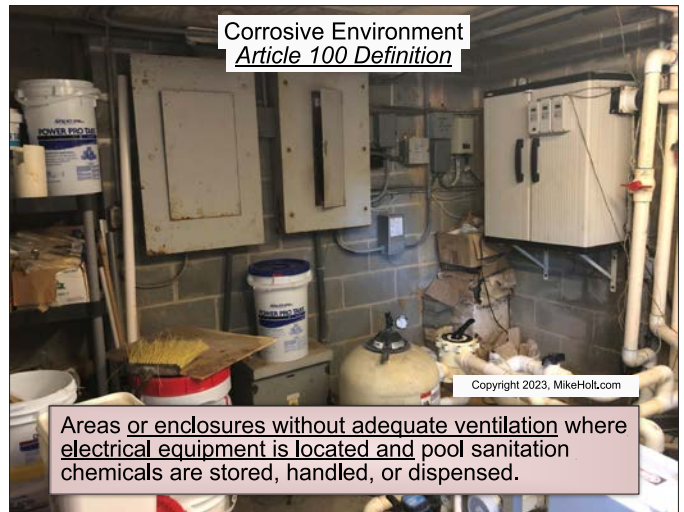

▶Figure 680-22

680.14 Corrosive Environment

(A) Wiring Methods. Wiring methods suitable for use in corrosive environments must be rigid metal conduit, intermediate metal conduit, rigid polyvinyl chloride conduit, reinforced thermosetting resin conduit, or liquidtight flexible nonmetallic conduit. ▶Figure 680-21

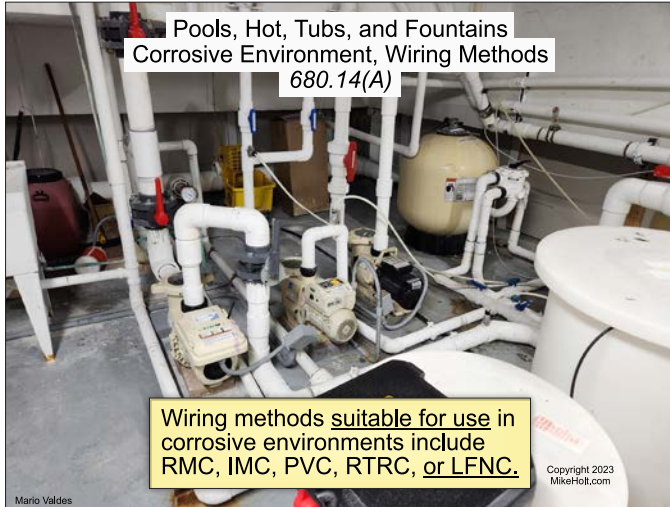

▶Figure 680-21

According to Article 100, a “Corrosive Environment” is areas or enclosures without adequate ventilation where electrical equipment is located and pool sanitation chemicals are stored, handled, or dispensed (Article 680). ▶Figure 680-22

Note 1: Sanitation chemicals and pool water pose a risk of corrosion (gradually damaging or destroying materials) due to the presence of oxidizers (for example, calcium hypochlorite, sodium hypochlorite, bromine, and chlorinated isocyanurates) and chlorinating agents that release chlorine when dissolved in water.

(B) Equipment. Equipment in a corrosive pool environment must be suitable for the use or be installed in identified corrosion-resistant enclosures. Equipment listed for use in pools and hot tubs are considered suitable for use in a corrosive pool environment. ▶Figure 680-23 and ▶Figure 680-24

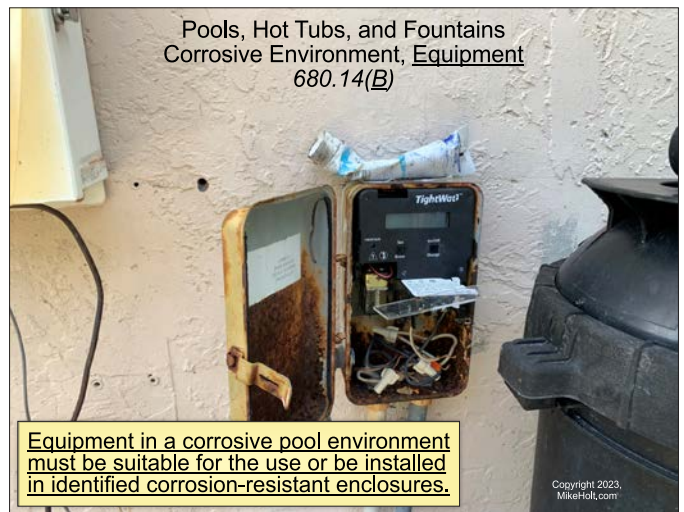

▶Figure 680-23

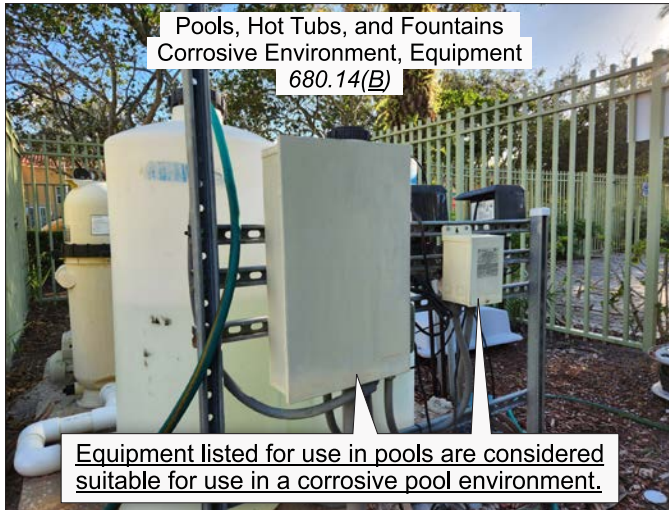

► Figure 680-24

Part II. Permanently Installed Pools

680.20 General

The requirements contained in Part I and Part II apply to permanently installed pools as defined by Article 100.

According to Article 100, a “Pool, Permanently Installed” is a pool constructed or installed in the ground or partially in the ground, and pools installed inside of a building (Article 680). ► **Figure 680-25**



► Figure 680-25

680.21 Pool Pump Motors

(A) Wiring Methods. The wiring to a pool pump motor must comply with 680.21(A)(1) or (A)(2).

(1) Flexible Connections. If flexible connections are necessary, liquid-tight flexible metal conduit, liquidtight flexible nonmetallic conduit, and Type MC cable suitable for the use are permitted. ► **Figure 680-26**

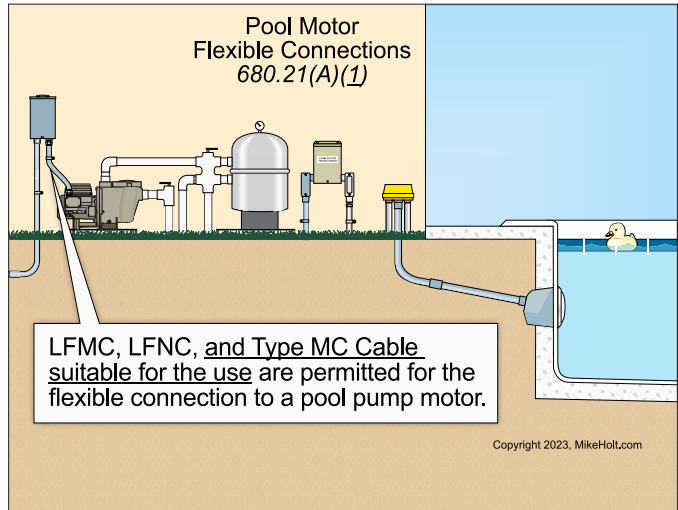

► Figure 680-26

(C) GFCI and SPGFCI Protection. GFCI protection is required for pool pump motor outlets rated 150V or less to ground and SPGFCI protection is required for pool pump motor outlets rated above 150V to ground. ► **Figure 680-27**

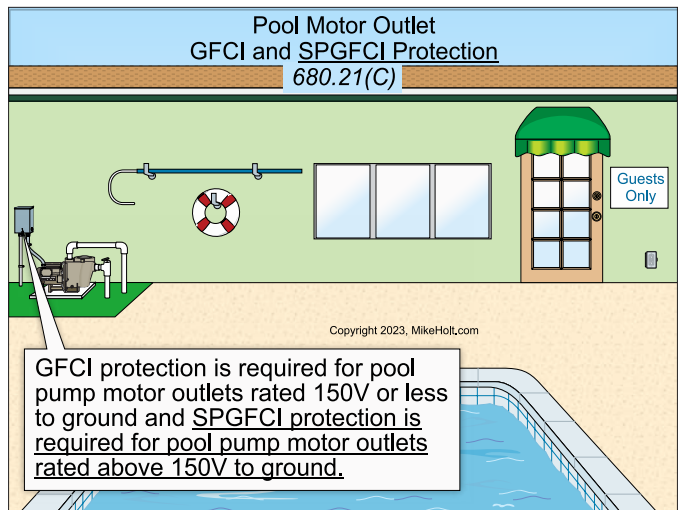

► Figure 680-27

(D) Pool Pump Motor Replacement. Where a pool pump motor is replaced or repaired, the replacement or repaired pump motor must be provided with GFCI or SPGFCI protection in accordance with 680.5(B) or (C). ▶Figure 680-28

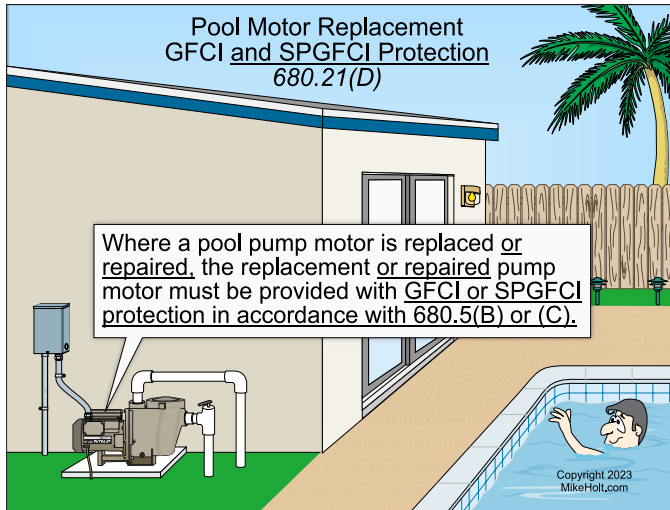

▶Figure 680-28

(2) Circulation System Receptacle. Receptacles for pool motors or other loads directly related to the circulation system, must be at least 6 ft from the inside walls of the pool and have GFCI protection. ▶Figure 680-30

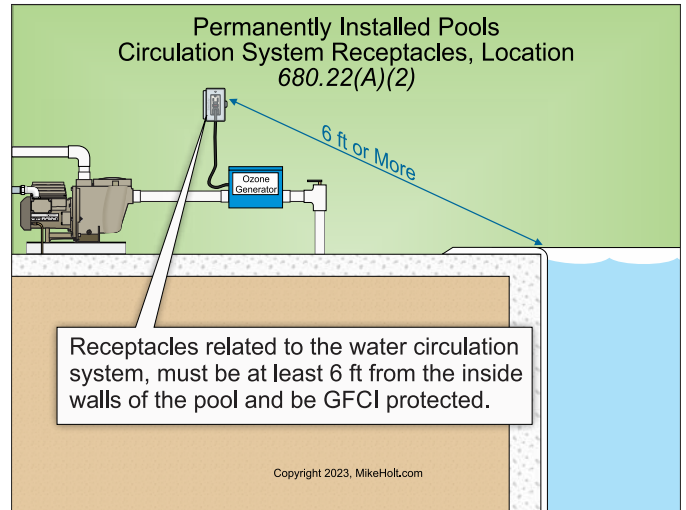

▶Figure 680-30

680.22 Receptacles, Luminaires, and Switches

(A) Receptacles.

(1) Required Receptacle. At least one 15A or 20A, 125V receptacle installed on a general-purpose branch circuit must be not less than 6 ft and not more than 20 ft from the inside wall of a pool. This receptacle must be not more than 6½ ft above the floor, platform, or grade level serving the pool. ▶Figure 680-29

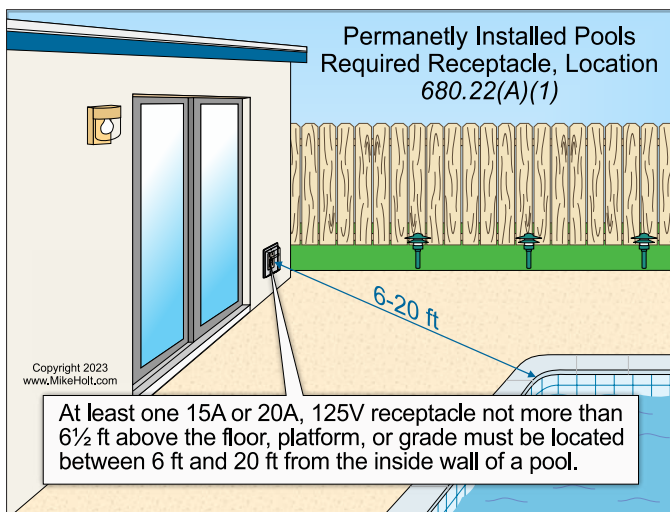

▶Figure 680-29

(3) Other Receptacles. Receptacles for loads not directly related to the circulation system must be not less than 6 ft from the inside walls of a pool. ▶Figure 680-31



▶Figure 680-31

(4) GFCI. Receptacles rated 125V through 250V, 60A or less within 20 ft of the inside wall of a pool must have GFCI protected.

(5) How to Measure. When measuring receptacle distances from the pool water, the measurement is the shortest path a supply cord would follow without piercing a floor, wall, or ceiling, sliding door, window, or other barrier. ▶Figure 680-32



▶Figure 680-32

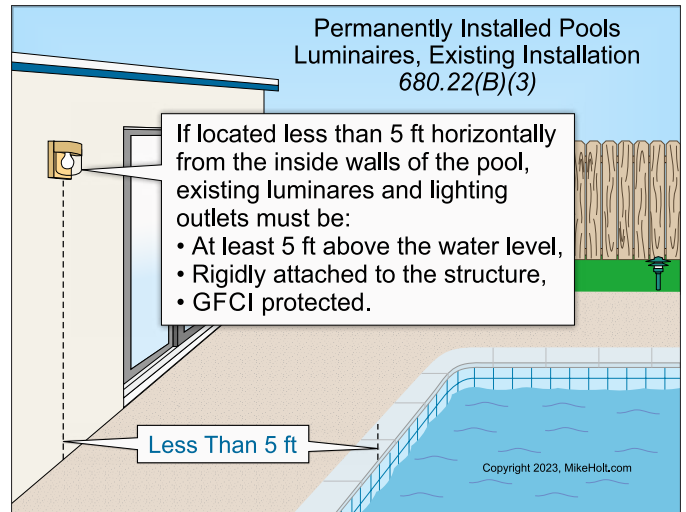

▶Figure 680-34

(B) Luminaires and Ceiling Fans.

(1) New Outdoor Installations. Luminaires and lighting outlets installed not less than 5 ft horizontally from the inside walls of a permanently installed pool must be not less than 12 ft above the maximum water level. ▶Figure 680-33

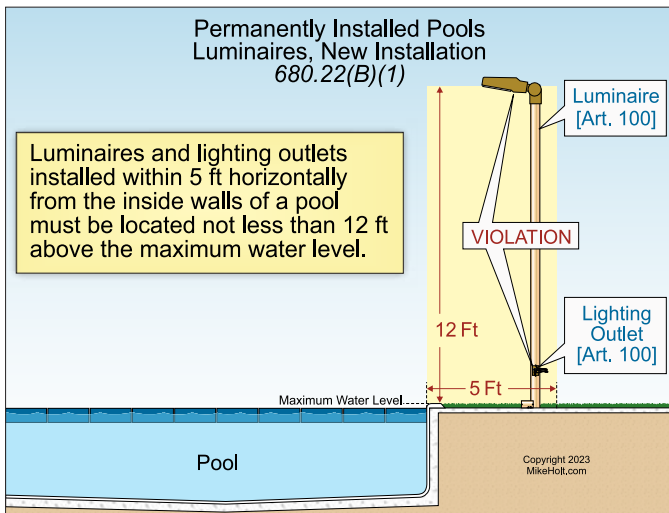

▶Figure 680-33

(3) Existing Installations. Existing lighting outlets within 5 ft horizontally from the inside walls of a permanently installed pool must not be less than 5 ft above the surface of the maximum water level, be rigidly attached to the existing structure, and be GFCI protected. ▶Figure 680-34

(4) GFCI and SPGFCI Protection. All luminaires, lighting outlets, and ceiling fans between 5 ft and 10 ft horizontally from the inside walls of a permanently installed pool, and not less than 5 ft above the maximum water level must have GFCI protection in accordance with 680.5(B) or SPGFCI protection in accordance with 680.5(C). ▶Figure 680-35

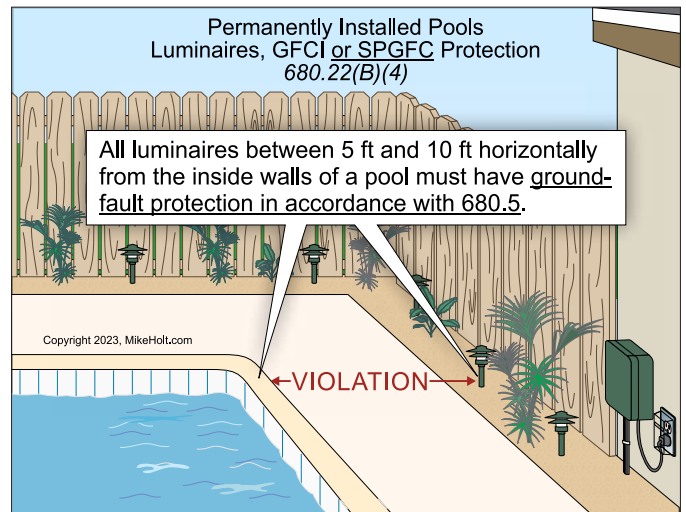

▶Figure 680-35

(6) Low-Voltage Luminaires. Low-voltage lighting systems that are listed, labeled, and identified for swimming pools can be installed without any distance limits to the water. ▶Figure 680-36

All other low-voltage lighting must not be installed within 10 ft from the edge of the water in accordance with 411.6(B). ▶Figure 680-37

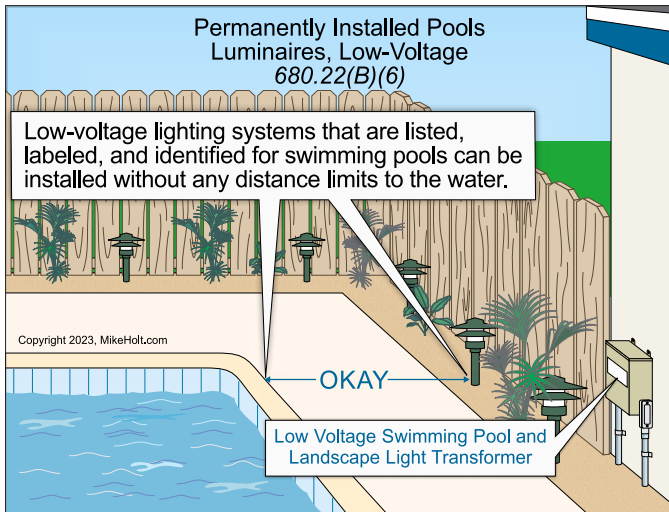

▶ Figure 680-36

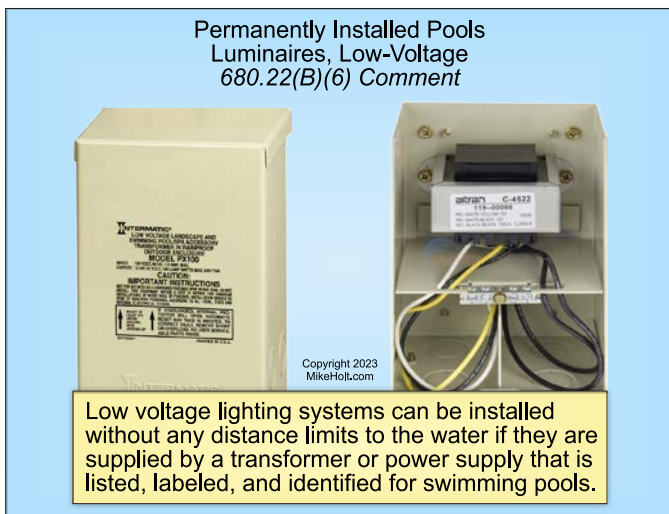

▶ Figure 680-37

(7) Low-Voltage Gas-Fired Luminaires, Fireplaces, Fire Pits, and Similar Equipment. Listed gas-fired luminaires, fireplaces, fire pits, and similar equipment using low-voltage ignitors supplied by listed transformers or power supplies that comply with 680.23(A)(2) and do not exceed the low-voltage contact limit can be less than 5 ft from the inside walls of the pool.

(8) Measurements. In determining the dimensions in this section addressing luminaires, the distance to be measured must be the shortest path an imaginary cord connected to the luminaire will follow without piercing a floor, wall, ceiling, doorway with a hinged or sliding door, window opening, or other effective permanent barrier.

(C) Switching Devices. Circuit breakers, time clocks, pool light switches, and other switching devices must be not less than 5 ft horizontally from the inside walls of a pool unless separated by a solid fence, wall, or other permanent barrier that provides at least a 5-ft reach distance. ▶ Figure 680-38

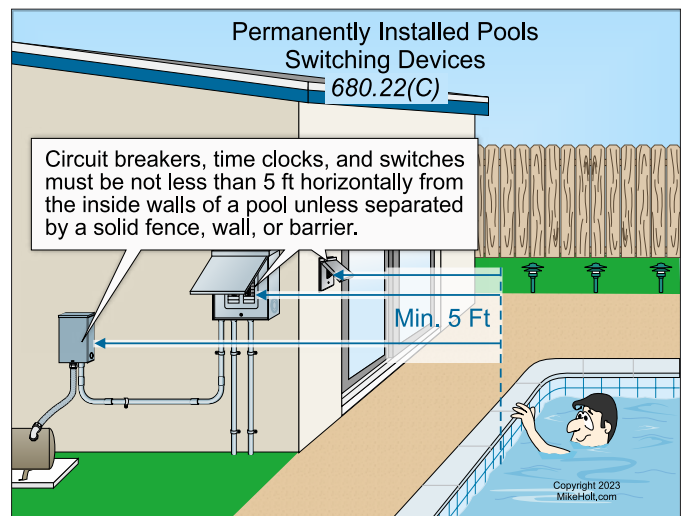

▶ Figure 680-38

(E) Equipment. Equipment must be located at least 5 ft horizontally from the inside walls of a pool unless separated by a solid fence, wall, or other permanent barrier. ▶ Figure 680-39

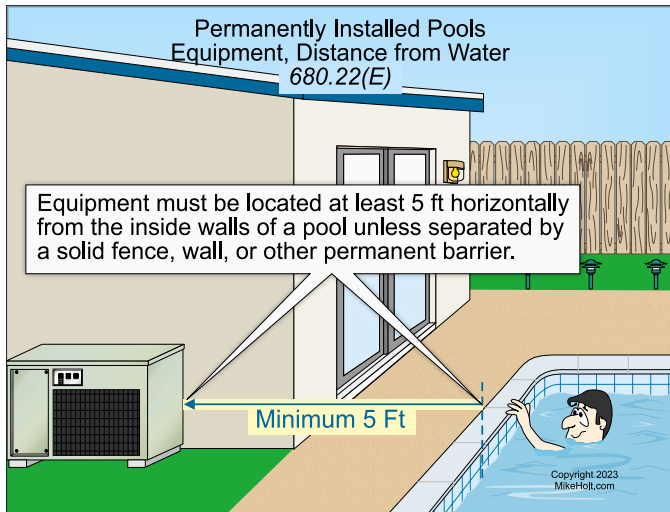

▶ Figure 680-39

680.23 Underwater Pool Luminaires

This section covers all luminaires installed below the maximum water level of the pool.

(A) General.

(2) Transformers and Power Supplies for Underwater Pool Luminaires. Transformers and power supplies for underwater pool luminaires must be listed, labeled, and identified for swimming pool use.

(3) GFCI Protection. Branch circuits supplying 120V underwater pool luminaires must be GFCI protected. ▶ Figure 680-40

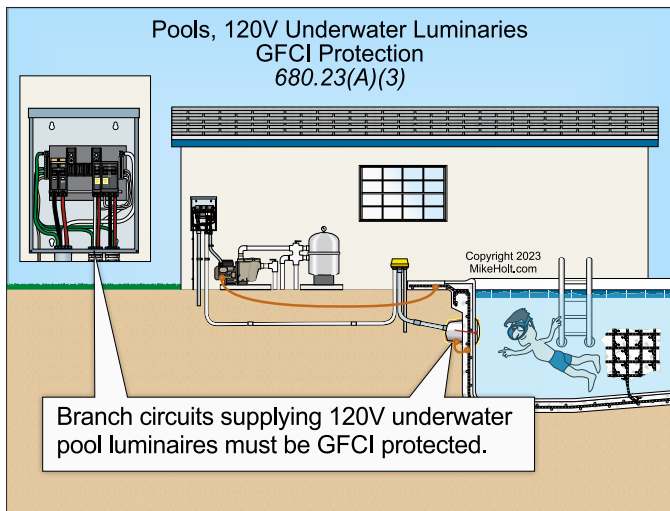

▶ Figure 680-40

(5) Wall-Mounted Luminaires. Underwater wall-mounted luminaires must be installed so the top of the luminaire lens is not less than 18 in. below the normal water level. ▶ Figure 680-41

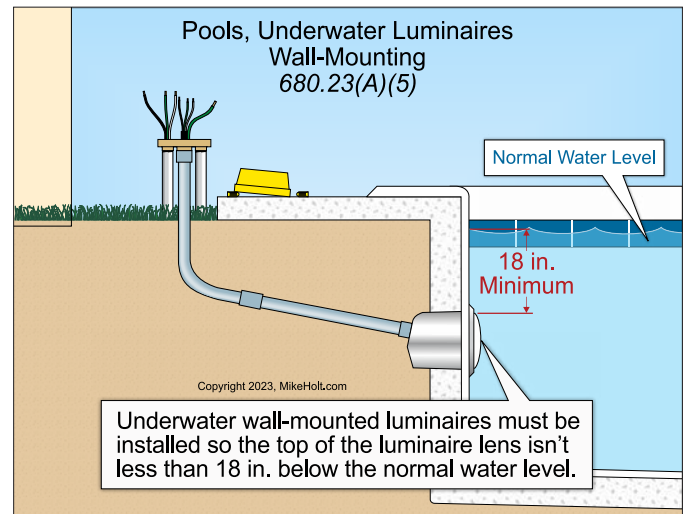

▶ Figure 680-41

(B) Wet-Niche Luminaires.

(1) Wet-Niche Forming Shells. Forming shells must be installed for the mounting of all wet-niche underwater luminaires. Forming shells must include provisions for terminating an 8 AWG copper conductor unless the forming shell is part of a listed low-voltage lighting system.

According to Article 100, a “Forming Shell” is defined as a structure designed to support a wet-niche luminaire (Article 680). ▶ Figure 680-42



▶ Figure 680-42

According to Article 100, a “Luminaire, Wet-Niche” is a luminaire intended to be installed in a forming shell where it will be surrounded by water (Article 680). ▶Figure 680–43

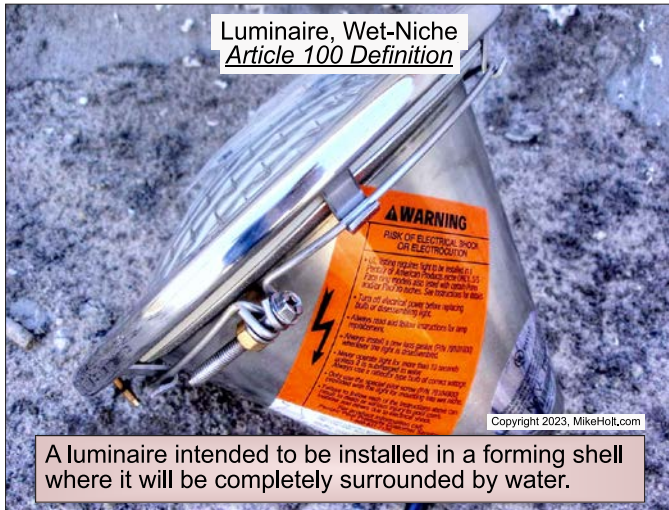

▶Figure 680–43

(2) Wiring to the Wet-Niche Forming Shell.

(b) PVC Raceway.

120V Wet-Niche Luminaire. A PVC raceway run to the forming shell of a wet-niche luminaire must contain an 8 AWG insulated copper conductor that terminates to the forming shell. ▶Figure 680–44

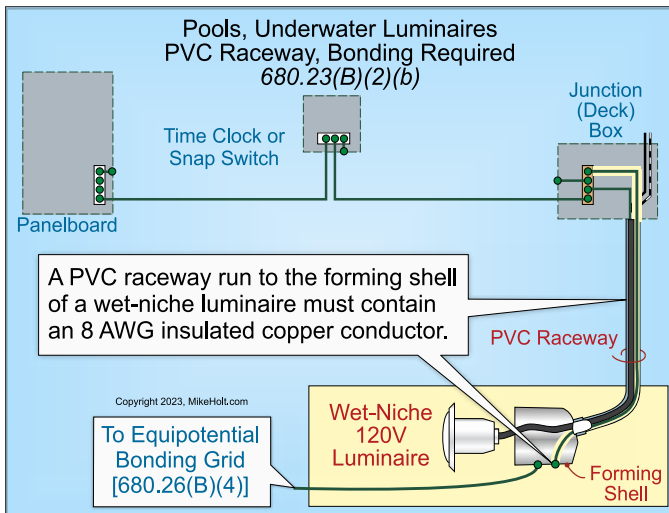

▶Figure 680–44

Low-Voltage Lighting System. A PVC raceway run to the forming shell of a listed low-voltage lighting system that does not require grounding does not require an 8 AWG insulated copper conductor to the forming shell. ▶Figure 680–45

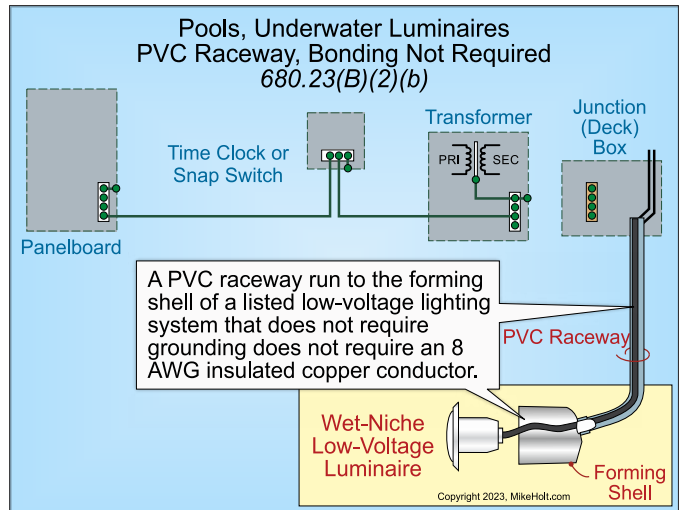

▶Figure 680–45

The termination of the 8 AWG bonding jumper in the forming shell must be covered with a listed potting compound to protect the connection from the possible deteriorating effects of pool water.

(3) Equipment Grounding Provisions for Cords. The cord or cable supplying a low-voltage underwater luminaire that does not require grounding does not require an insulated copper equipment grounding conductor. ▶Figure 680–46

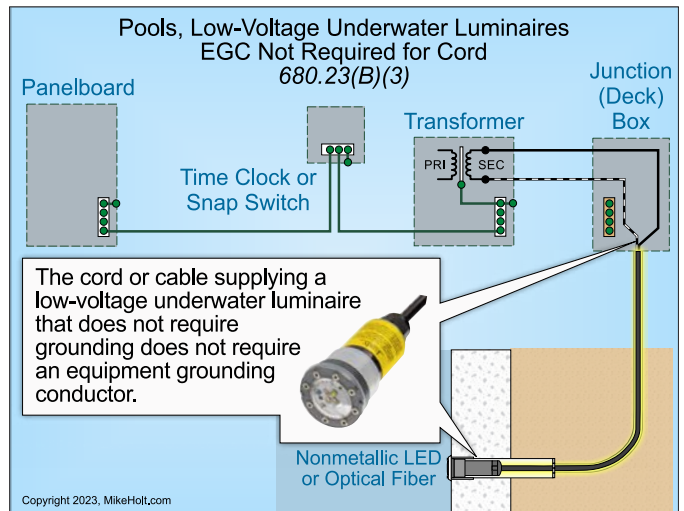

▶Figure 680–46

(6) Underwater Luminaire Servicing. The location of the forming shell and length of flexible cord for wet-niche pool luminaires must allow for personnel to place the luminaire on the deck for maintenance.

(F) Branch-Circuit Wiring to Underwater Luminaires.

(1) Wiring Methods. Branch-circuit wiring for underwater luminaires run in corrosive environments must be in rigid metal conduit, intermediate metal conduit, rigid polyvinyl chloride conduit, reinforced thermosetting resin conduit, or liquidtight flexible nonmetallic conduit [680.14].

▶Figure 680-47

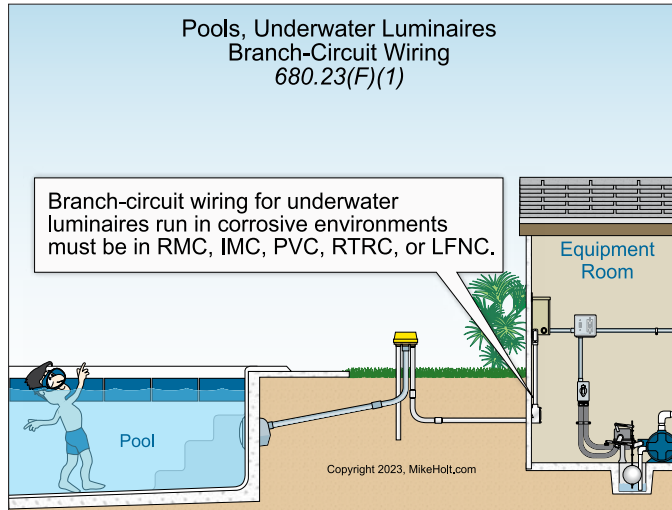

▶Figure 680-47

(2) Branch-Circuit Equipment Grounding Conductor.

Wet-Niche 120V Luminaires. An insulated copper equipment grounding conductor not smaller than 12 AWG is required for a wet-niche 120V underwater luminaires. ▶Figure 680-48

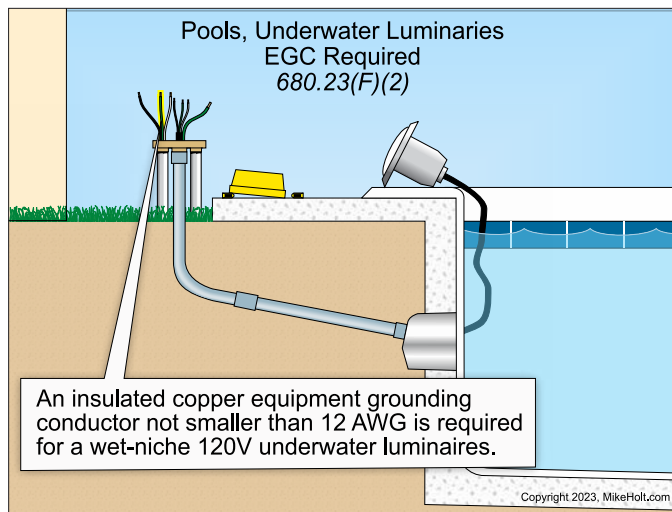

▶Figure 680-48

Low-Voltage Luminaires. An equipment grounding conductor is not required for a low-voltage underwater luminaires listed as not requiring grounding. ▶Figure 680-49

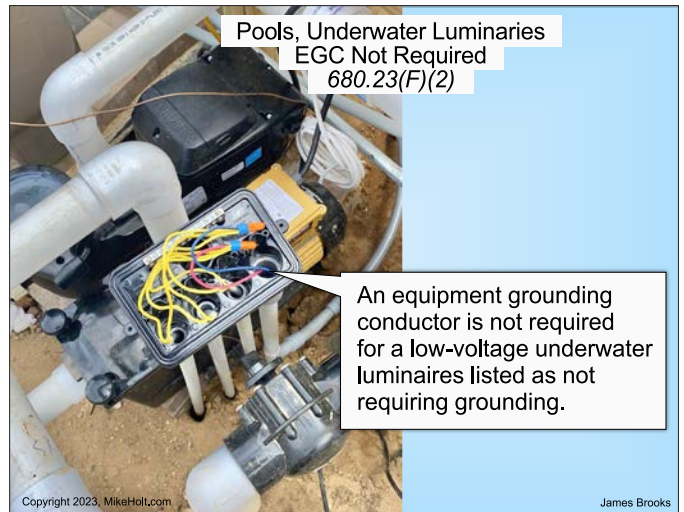

▶Figure 680-49

The circuit equipment grounding conductor for the underwater pool luminaire is not permitted to be spliced, except for the following applications:

- (a) If more than one underwater pool luminaire is supplied by the same branch circuit, the circuit equipment grounding conductor can terminate at a listed pool junction box meeting the requirements of 680.24(A).
- (b) The circuit equipment grounding conductor can terminate at the grounding terminal of a pool light time clock, listed pool transformer, and pool light junction box. ▶Figure 680-50

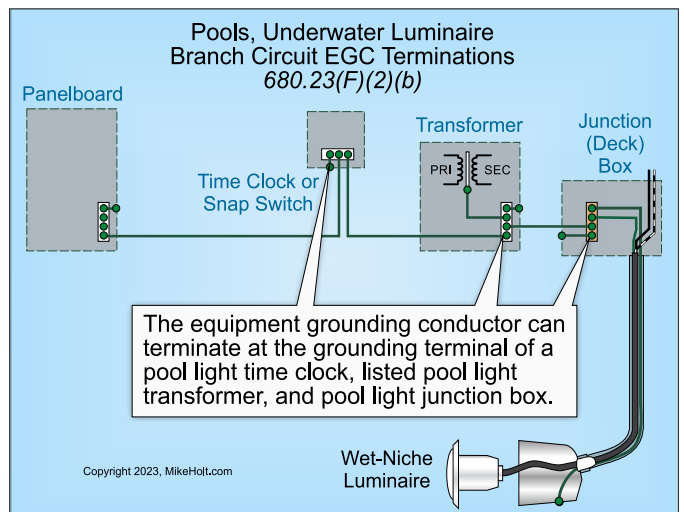

▶Figure 680-50

(3) Conductors. The branch-circuit conductors for the underwater pool luminaire on the load side of a GFCI or transformer used to comply with 680.23(A)(8) are not permitted to occupy raceways or enclosures with other conductors unless the other conductors are:

- (1) GFCI protected
- (2) Equipment grounding conductors and bonding jumpers as required by 680.23(B)(2)(b)

680.24 Junction Box, Transformer, or GFCI Enclosure

(A) Junction Box. If a junction box is connected to a raceway that extends directly to an underwater pool luminaire forming shell, the junction box must comply with the following:

(1) Construction. The junction box must be listed, labeled, and identified as a swimming pool junction box. ▶ **Figure 680-51**

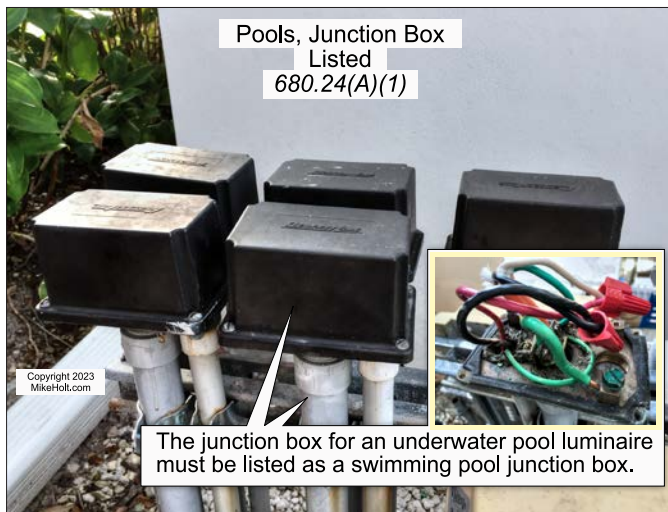

▶ **Figure 680-51**

(2) Installation.

(a) Vertical Spacing. If the underwater pool luminaire operates at 120V, the junction box must be not less than 4 in. above the ground or pool, or not less than 8 in. above the maximum water level, whichever provides the greater elevation. ▶ **Figure 680-52**

(b) Horizontal Spacing. If the underwater pool luminaire operates at 120V, the junction box must be not less than 4 ft from the inside wall of the pool unless separated by a solid fence, wall, or other permanent barrier. ▶ **Figure 680-53**

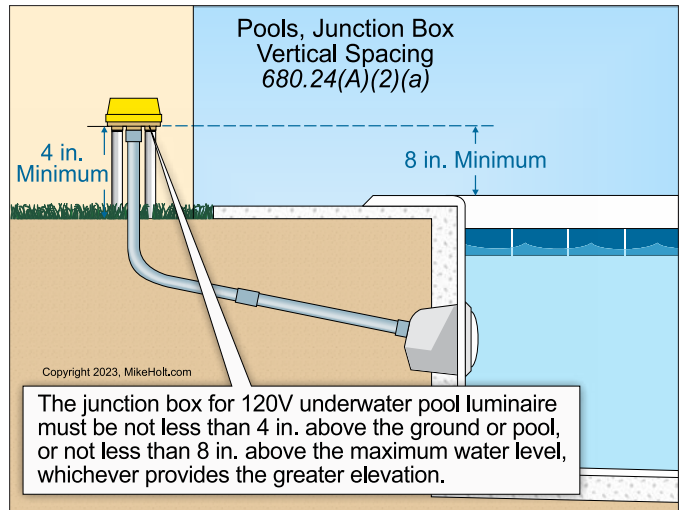

▶ **Figure 680-52**

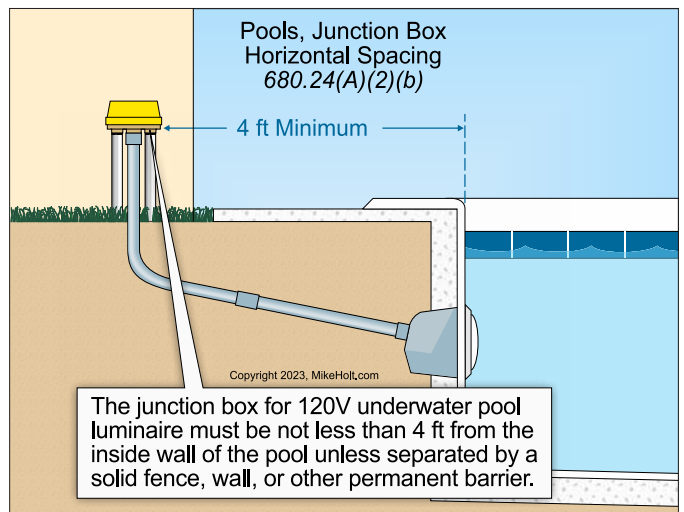

▶ **Figure 680-53**

Author's Comment:

- ▶ If conduits are used to support the junction box, the junction box must be supported by two metal conduits threaded wrenchtight into the enclosure according to 314.23(E).

(B) Transformer or GFCI Enclosure. The transformer or GFCI enclosure connected to a raceway that extends directly to an underwater luminaire forming shell must be listed for this purpose.

Author's Comment:

- ▶ A pool junction box is still required for the direct connection to an underwater luminaire.



Have an NEC® Question?
Join the Mike Holt Code Community

Forum Topics include:
NEC | Electrical Calculations | Engineering | Business Management | Estimating | Bonding and Grounding | Limited Energy | Education | Safety

MikeHolt.com/Forum

(C) Physical Protection. Junction boxes for underwater luminaires are not permitted to be in a walkway unless afforded protection by being under diving boards or adjacent to fixed structures.

(F) Equipment Grounding Conductor Termination. The equipment grounding of the wire-type required for a junction box, transformer enclosure, or GFCI enclosure for the connection of an underwater pool luminaire must terminate to the panelboard enclosure. ▶Figure 680-54

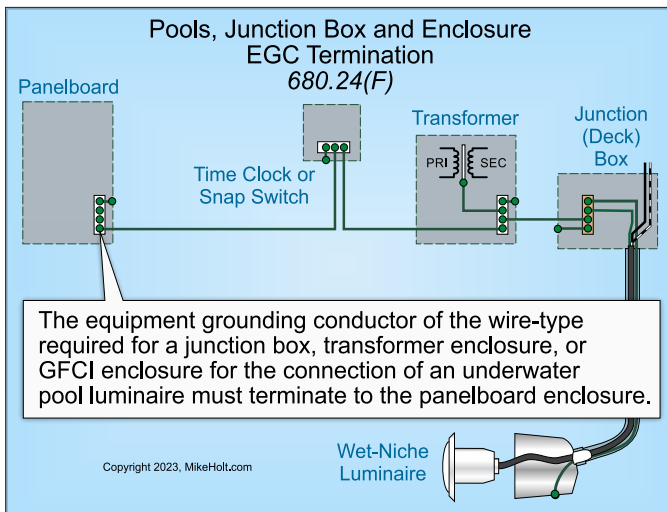

▶Figure 680-54

680.26 Equipotential Bonding

(A) Voltage Gradients. Equipotential bonding is intended to reduce voltage gradients in the area around a permanently installed pool.

▶Figure 680-55

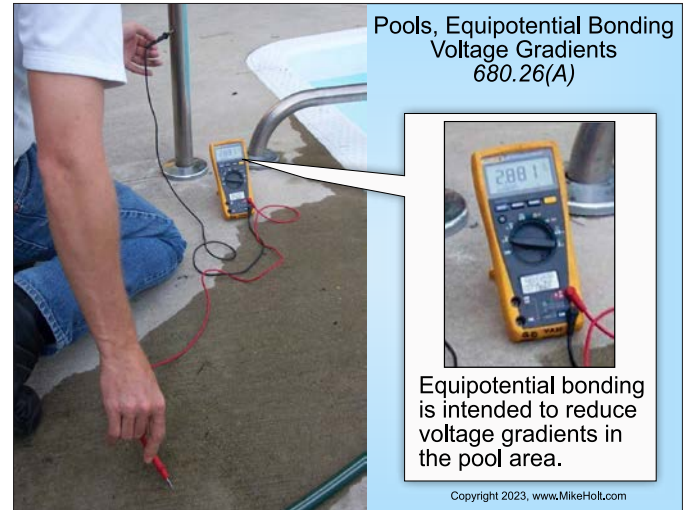

▶Figure 680-55

Equipotential bonding must be installed for pools with or without associated electrical equipment related to the pool.

(B) Equipotential Bonded. The parts of a permanently installed pool listed in 680.26(B)(1) through (B)(7) must be bonded together with a solid insulated or bare copper conductor not smaller than 8 AWG using a listed pressure connector, terminal bar, or other listed means in accordance with 250.8(A) [and 680.7]. ▶Figure 680-56

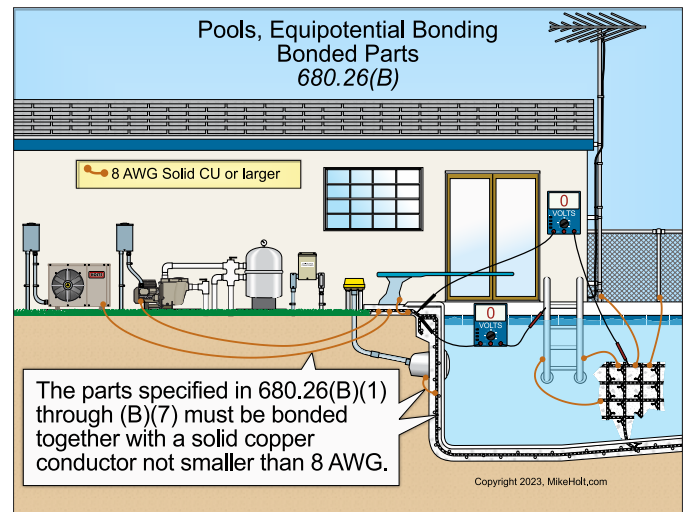

▶Figure 680-56

The 8 AWG equipotential bonding conductor is not required to extend (or be attached) to any panelboard, service disconnect, or grounding electrode.

(1) Conductive Pool Shells. Cast-in-place concrete, pneumatically applied or sprayed concrete, and concrete block with painted or plastered coatings must be bonded. Reconstructed conductive pool shells must be bonded.

(a) Structural Reinforcing Steel. Unencapsulated structural reinforcing steel rebar in conductive pool shells must be bonded. ▶**Figure 680-57**

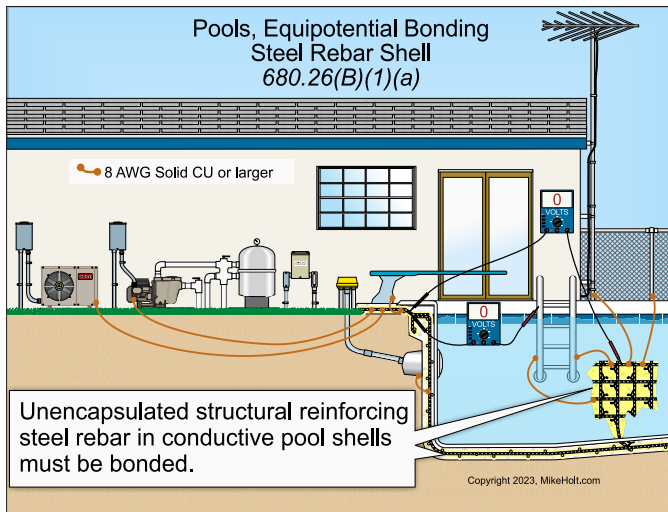

▶**Figure 680-57**

(b) Copper Conductor Grid. Where structural reinforcing steel is encapsulated in a nonconductive compound, a copper conductor grid must be installed as follows: ▶**Figure 680-58**

- (1) Be constructed of a minimum of 8 AWG bare solid copper conductors bonded to each other at all points of crossing in accordance with 250.8 [and 680.7], or other approved means.
- (2) Conform to the contour of the pool.
- (3) Be arranged in a 12-in. by 12-in. network of conductors in a uniformly spaced perpendicular grid pattern with a tolerance of 4 in.
- (4) Be secured within or under the pool no more than 6 in. from the outer contour of the pool shell. ▶**Figure 680-59**

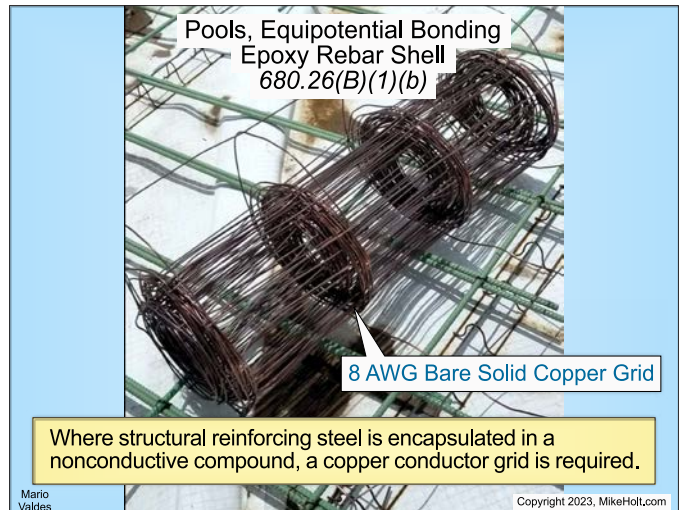

▶**Figure 680-58**



▶**Figure 680-59**

Author's Comment:

- ▶ Encapsulated structural reinforcing steel is used to prevent rebar corrosion and (if used) will make the pool shell insulated, therefore a conductive copper grid is required to bond the pool shell.
- ▶ If split bolts are used to bond the copper conductor grid, they are only suitable for 2 wires unless identified otherwise [110.14(A)]. ▶**Figure 680-60**

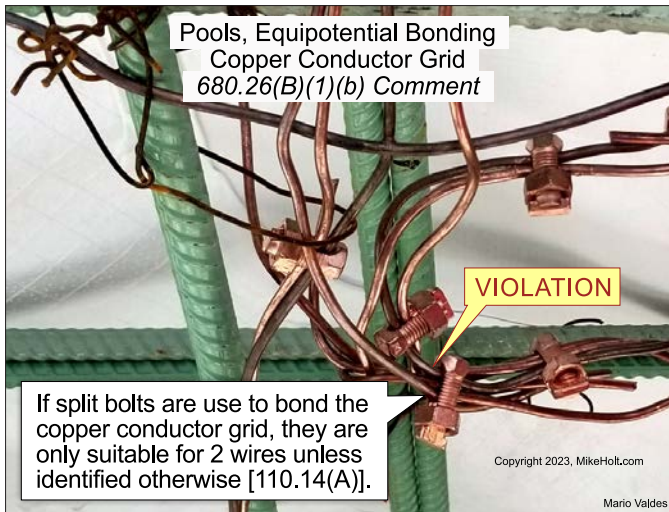

▶Figure 680-60

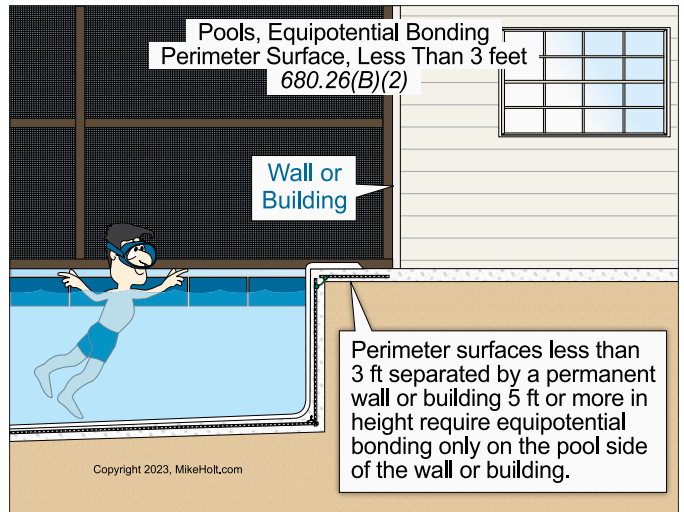

▶Figure 680-62

(2) Perimeter Surfaces. Equipotential bonding for the perimeter surface must extend a minimum of 3 ft horizontally from the inside walls of a pool where not separated by a building or permanent wall 5 ft in height. ▶Figure 680-61

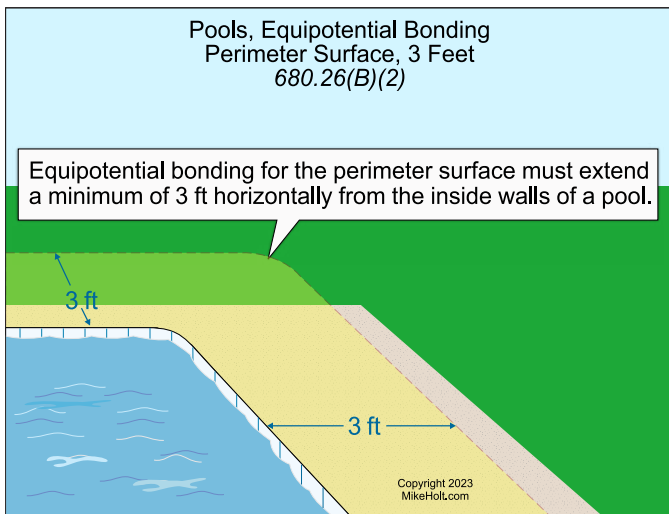

▶Figure 680-61

Perimeter surfaces less than 3 ft separated by a permanent wall or building 5 ft or more in height require equipotential bonding only on the pool side of the wall or building. ▶Figure 680-62

For conductive pool shells, equipotential bonding for perimeter surfaces must be attached to the concrete pool reinforcing steel rebar or copper conductor grid at a minimum of four points uniformly spaced around the perimeter of the pool and be one of the following: ▶Figure 680-63

(a) Structural Reinforcing Steel Rebar. Unencapsulated structural reinforcing steel bonded together by steel tie wires or the equivalent in accordance with 680.26(B)(1)(a). ▶Figure 680-64

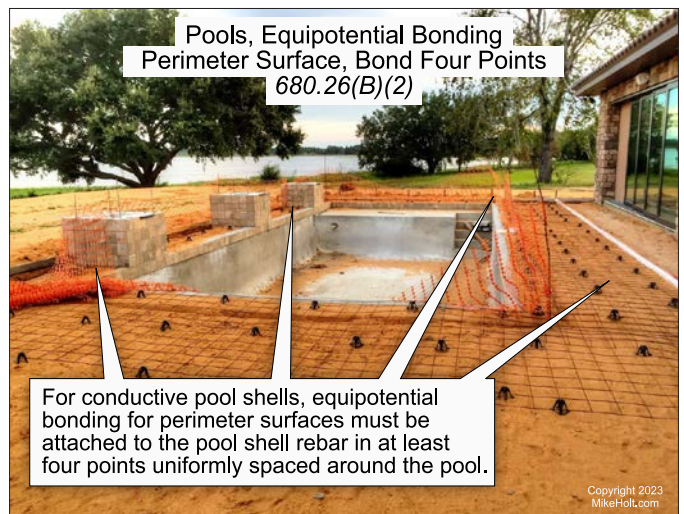

▶Figure 680-63

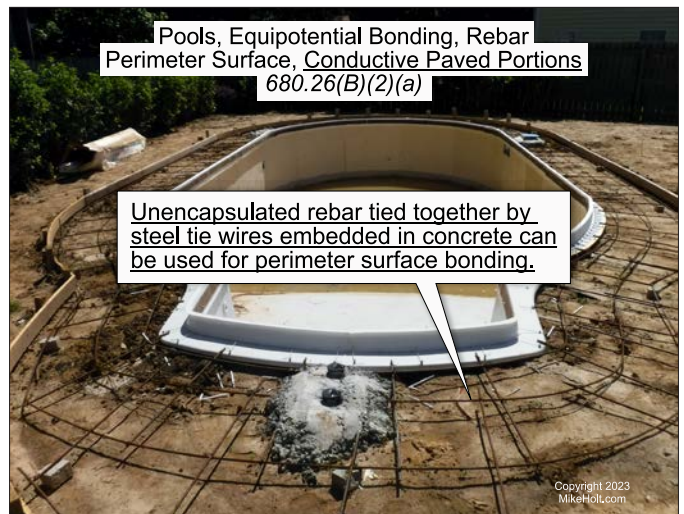

▶Figure 680-64

Author's Comment:

- ▶ The *NEC* does not provide a layout requirement for conductive structural steel when used as a perimeter surface equipotential bonding method. ▶ **Figure 680-65**

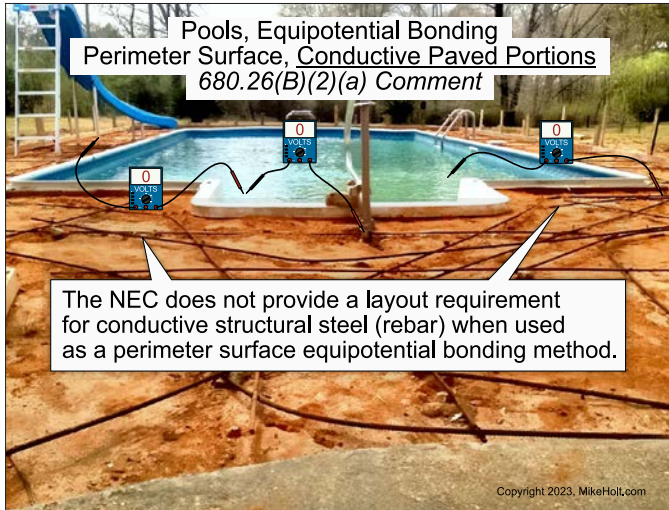
▶ **Figure 680-65**

(b) Copper Ring. Where structural reinforcing steel is not available or is encapsulated in a nonconductive compound, a copper conductor can be used for equipotential perimeter bonding where the following requirements are met: ▶ **Figure 680-66**

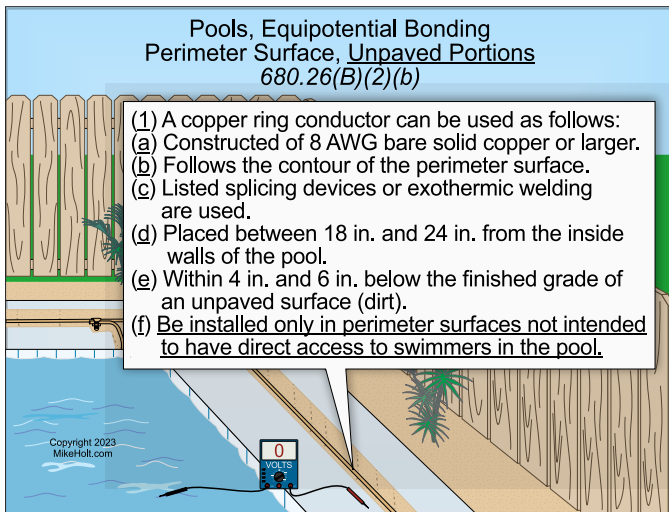
▶ **Figure 680-66**

- (1) The copper ring is constructed of 8 AWG bare solid copper or larger.
- (2) The copper ring conductor follows the contour of the perimeter surface.
- (3) Only listed splicing devices or exothermic welding are used.

- (4) The copper ring conductor is placed between 18 in. and 24 in. from the inside walls of the pool.
- (5) The copper ring conductor is secured within a paved surface (concrete), no more than 6 in. below finished grade of the paved surface (pavers or concrete), or between 4 in. and 6 in. below the finished grade of an unpaved surface (dirt).

(c) Copper Grid. Where structural reinforcing steel is not available or is encapsulated in a nonconductive compound as an alternate method to a copper ring, a copper grid can be used for perimeter bonding where all the following requirements are met:

- (1) The copper grid is constructed of 8 AWG solid bare copper and arranged in a 12-in. by 12-in. network of conductors in a uniformly spaced perpendicular grid pattern with a tolerance of 4 in. in accordance with 680.26(B)(1)(b)(3).
- (2) The copper grid follows the contour of the perimeter surface extending 3 ft horizontally beyond the inside walls of the pool.
- (3) Only listed splicing devices or exothermic welding are used.
- (4) The copper grid is secured within a paved surface (concrete), no more than 6 in. below finished grade of the paved surface (pavers or concrete), or between 4 in. and 6 in. below the finished grade of an unpaved surface (dirt).

(3) Metal Parts of Pool Structure. Metal parts of the pool structure, not part of the pool shell [680.26(B)(1)(a)] must be bonded. ▶ **Figure 680-67**

▶ **Figure 680-67**

(4) Metal Forming Shells. All metal forming shells for underwater luminaires must be bonded. ▶ **Figure 680-68**



▶Figure 680-68

Ex: Listed low-voltage lighting are not required to be bonded.

(5) **Metal Pool Fittings.** Metal fittings attached to the pool structure such as ladders and handrails must be bonded. ▶Figure 680-69

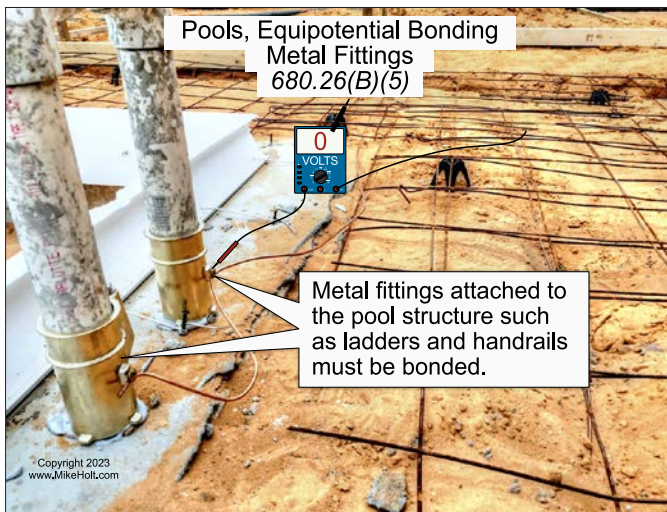

▶Figure 680-69

Ex: The following are not required to be bonded:

- (1) Isolated parts not over 4 in. in any dimension and not penetrating the pool structure more than 1 in.
- (2) Metallic pool cover anchors in a concrete or masonry deck, 1 in. or less in any dimension and 2 in. or less in length.
- (3) Metallic pool cover anchors in a wood or composite deck, 2 in. or less in any dimension and 2 in. or less in length.

(6) **Electrical Pool Equipment.** Metal parts of the following electrical equipment must be bonded.

- (1) Electrically powered pool cover(s)
- (2) Pool water circulation, treatment, heating, cooling, or dehumidification equipment ▶Figure 680-70

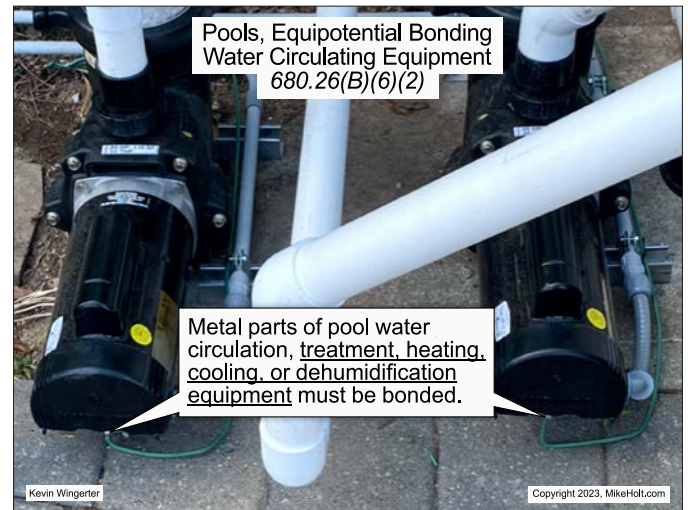

▶Figure 680-70

- (3) Other electrical equipment within 5 ft horizontally and 12 ft vertically from the inside walls of the pool, unless separated from the pool by a permanent barrier

(7) **Fixed Metal Parts.** Fixed metal parts of metal awnings, metal fences, metal doors, and metal window frames within 5 ft horizontally and 12 ft vertically from the inside walls of the pool must be bonded. ▶Figure 680-71

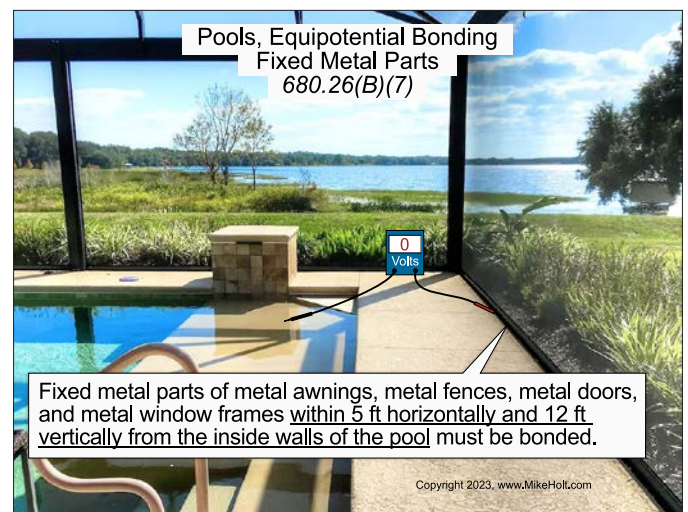

▶Figure 680-71

Ex: Fixed metal parts separated from the pool by a permanent barrier that prevents contact by a person are not required to be bonded. ▶Figure 680-72



▶ Figure 680-72

(C) Nonconductive Pool Shell. If the water in a vinyl or fiberglass pool shell does not make contact to one of the bonded parts in 680.26(B), a minimum 9 sq in. corrosion-resistant conductive surface in contact with the water must be bonded with a solid copper conductor not smaller than 8 AWG. ▶ Figure 680-73

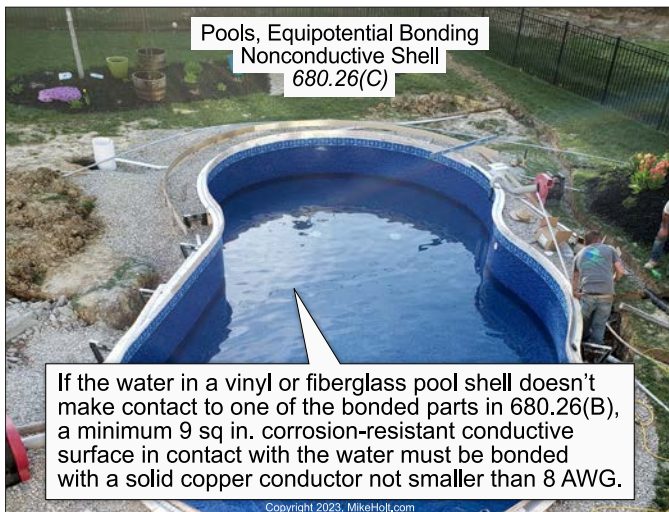

▶ Figure 680-73

Author's Comment:

- ▶ Where bonded items such as a conductive pool shell, metal ladders, metal rails, or underwater luminaires are in direct contact with the pool water and provide the required surface area, it is not necessary to install a corrosion-resistant conductive device.

680.27 Specialized Equipment**(B) Electrically Operated Covers.**

(1) Motors and Controllers. The electric motors, controllers, and wiring for an electrically operated cover must be not less than 5 ft from the inside wall of a permanently installed pool unless separated by a permanent barrier.

(2) GFCI Protection. The branch circuit serving the electric motor and controller circuit must be GFCI protected.

680.28 Gas-Fired Water Heaters

Circuits serving gas-fired swimming pool water heaters operating at 120V must be GFCI protected.

Part III. Storable Pools**680.30 General**

Electrical installations for storable pools must comply with Part I as well as Part III of Article 680.

Author's Comment:

- ▶ The requirements contained in Part I of Article 680 include definitions, cord-and-plug-connected equipment, overhead conductor clearances, and the location of maintenance disconnects.
- ▶ The equipotential bonding requirements contained in 680.26 (Part II of Article 680) do not apply to storable pools, storable spas, storable hot tubs, or storable immersion pools. ▶ Figure 680-74

Save 20% and Learn the 2023 Code®

Use Discount Code **NDX23**
MikeHolt.com/Code
 Discount applies to Mike Holt Code products



► Figure 680-75

680.31 Pumps

A cord-connected pool filter pump must incorporate an approved system of double insulation or its equivalent and be provided with means for the termination of an equipment grounding conductor for the noncurrent-carrying metal parts of the pump.

Cord-connected pool filter pumps must be provided with GFCI protection that is an integral part of the attachment plug, or in the power-supply cord within 12 in. of the attachment plug. ► **Figure 680-76**



► Figure 680-74

According to **Article 100**, a “Pool, Storable” is a pool installed entirely on or above the ground that is designed for ease of relocation, regardless of water depth (Article 680). ► **Figure 680-75**



► Figure 680-76

680.32 GFCI Protection

Receptacles rated 125V through 250V, 60A or less located within 20 ft from the inside walls of a storage pool must have GFCI or SPGFCI protection in accordance with 680.5(B) or (C). ▶Figure 680-77

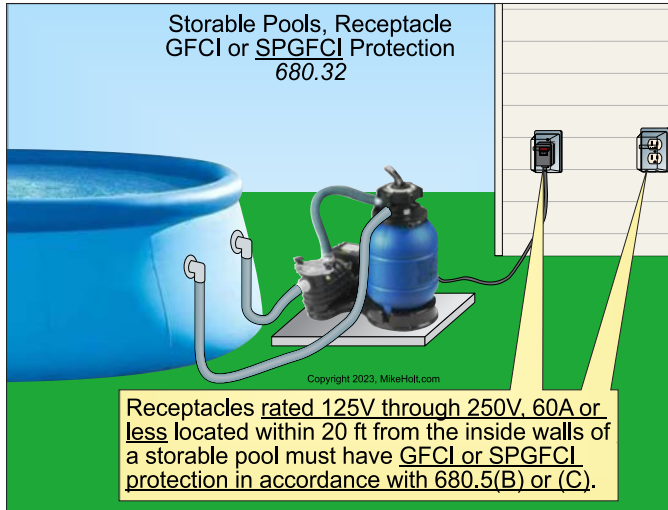

▶Figure 680-77

680.34 Receptacle Locations

Receptacles are not permitted to be less than 6 ft from the inside walls of a storage pool. The receptacle distance is measured as the shortest path a flexible cord will follow without passing through a wall, doorway, or window. ▶Figure 680-78

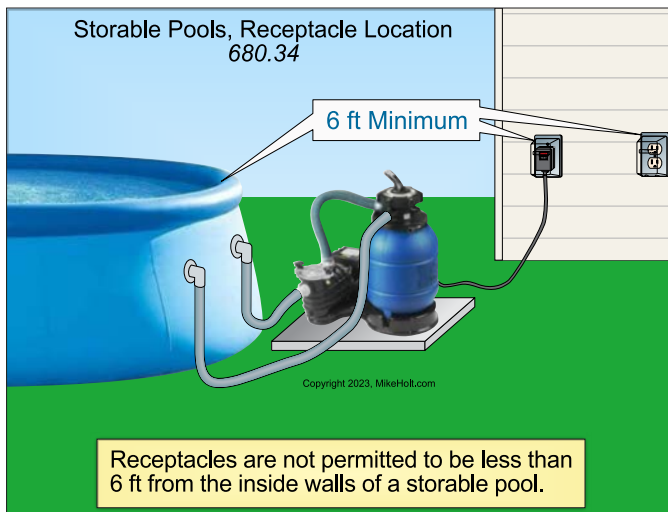

▶Figure 680-78

680.35 Storable Pools

Storable pools must comply with the additional requirements specified in 680.35(A) through (G) of the Code.

(A) Cord-Connected Storable Pool Equipment. Storable pool equipment rated 20A, single-phase, 120V or less are permitted to be cord connected if they are GFCI protected.

(B) Pumps. A storable pool pump must be listed, labeled, and identified for swimming pool use. ▶Figure 680-79



▶Figure 680-79

(C) Heaters. If rated 20A or 30A, single-phase, 120V or 250V, the heater must be GFCI protected.

(E) Lighting Outlets. Unless within the low-voltage contact limit, lighting outlets must be not less than 10 ft from the nearest point of an immersion pool.

(F) Switches. Switches, unless they are part of the unit, must be not less than 5 ft from the immersion pool.

(G) Receptacles. All 50A, 250V or less receptacles within 20 ft of the inside wall of a storage pool must be GFCI protected.

Part IV. Hot Tubs

680.40 General

Electrical installations for permanently installed self-contained hot tubs must comply with Part I as well as Part IV of Article 680.

According to Article 100, a “Spa or Hot Tub” is a hydromassage tub designed for recreational or therapeutic use typically not drained after each use (Article 680). ▶Figure 680–80



▶Figure 680–80

680.41 Emergency Shutoff Equipment

(A) Emergency Shutoff Switch for Hot Tubs. For other than a one-family dwelling, a labeled emergency hot tub water recirculation and jet system shutoff is required. The emergency shutoff switch must be readily accessible to the users and not less than 5 ft away, adjacent to, and within sight of the hot tub. ▶Figure 680–81

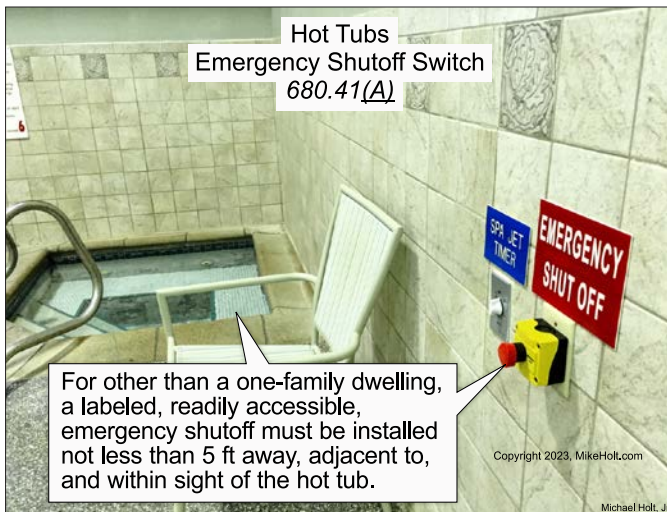

▶Figure 680–81

Author’s Comment:

- ▶ Either the equipment disconnect [680.13] or a pushbutton that controls a relay can be used to meet the emergency shutoff requirement. ▶Figure 680–82

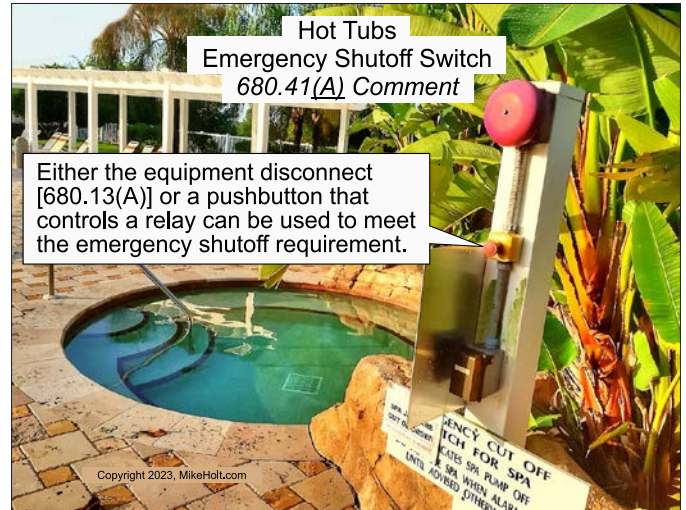

▶Figure 680–82

- ▶ The purpose of the emergency shutoff is to protect users from becoming entrapped by the water recirculating system intake. Deaths and injuries have occurred in less than 3 ft of water because individuals became stuck to the water intake opening. This requirement applies to hot tubs installed indoors as well as outdoors.

680.42 Outdoor Installations

A hot tub installed outdoors must comply with the bonding requirements of Article 680 Part II, except as permitted in 680.42(A). ▶Figure 680–83

(B) Equipotential Bonding.

Bonding Required. Equipotential bonding of perimeter surfaces of hot tubs is required in accordance with 680.26.

Bonding Not Required. Bonding for hot tubs is required, unless all the following conditions apply:

- (1) The hot tub is listed, labeled, and identified as a self-contained hot tub for aboveground use. ▶Figure 680–84
- (2) The hot tub is not identified as suitable only for indoor use.
- (3) The hot tub is on or above grade.

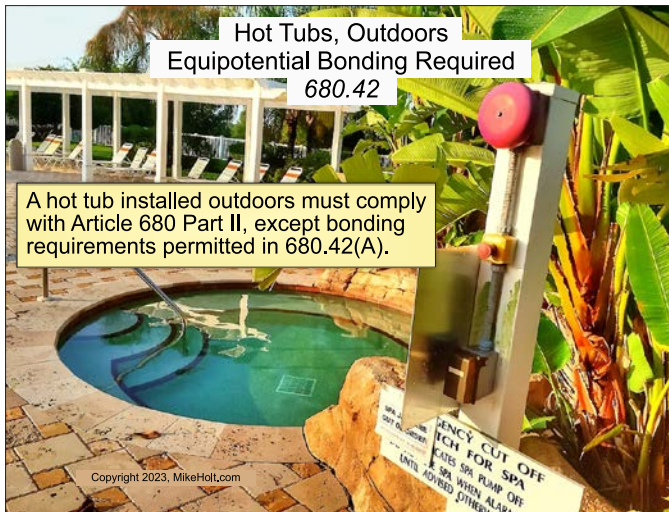

►Figure 680-83

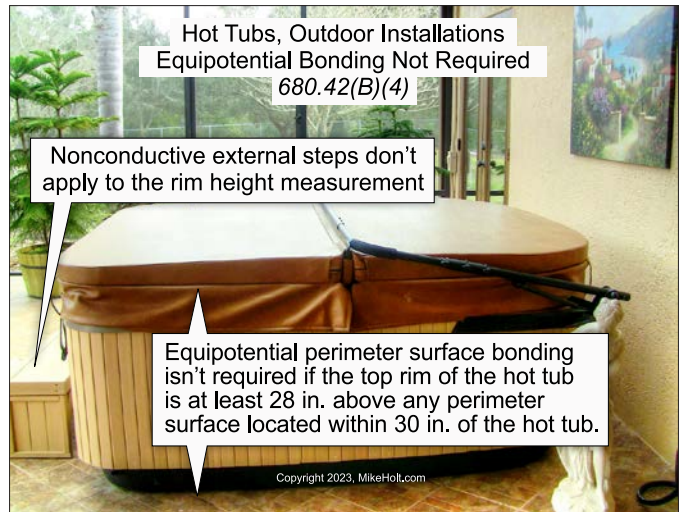

►Figure 680-85

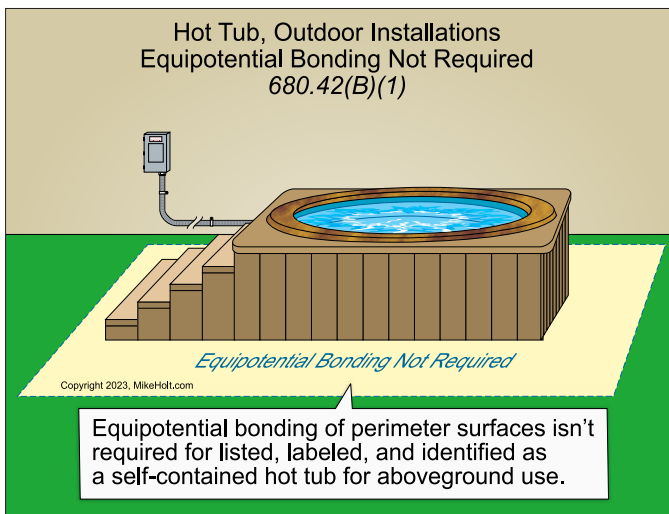

►Figure 680-84

(4) The top rim of the hot tub is at least 28 in. above any perimeter surface within 30 in. of the hot tub. Nonconductive external steps do not apply to the rim height measurement. ►Figure 680-85

(C) Underwater Luminaires. Wiring to an underwater luminaire in a hot tub must comply with 680.23 or 680.33.

680.43 Indoor Installations

Electrical installations for an indoor hot tub must comply with Parts I and II of Article 680 except as modified by this section.

Indoor installations of spas or hot tubs can be connected by any of the wiring methods contained in Chapter 3.

Ex 2: The equipotential bonding requirements for perimeter surfaces contained in 680.26(B)(2) do not apply to a listed self-contained hot tub installed above an indoor finished floor.

(A) Receptacles. At least one 15A or 20A, 125V receptacle on a general-purpose branch circuit must be not less than 6 ft and not more than 10 ft from the inside wall of a hot tub. ►Figure 680-86

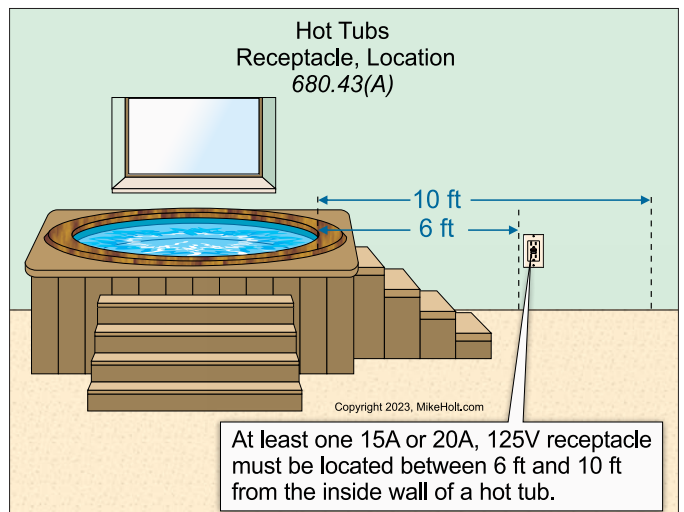

►Figure 680-86

(1) Location. Receptacles must be not less than 6 ft measured horizontally from the inside walls of the hot tub.

(2) GFCI Protection. Receptacles rated 125V through 250V, rated 60A or less within 10 ft of the inside walls of a hot tub must have GFCI protection in accordance with 680.5(B).

(3) Protection, Hot Tub Supply Receptacle. Receptacles that provide power for hot tub equipment must be GFCI protected.

(4) Measurements. In determining the dimensions in this section, the distance to be measured is the shortest path a cord of an appliance connected to the receptacle will follow without piercing a floor, wall, ceiling, doorway with a hinged or sliding door, window opening, or other type of permanent barrier.

(C) Switches. Switches must be at least 5 ft, measured horizontally, from the inside wall of the indoor hot tub. ▶Figure 680-87

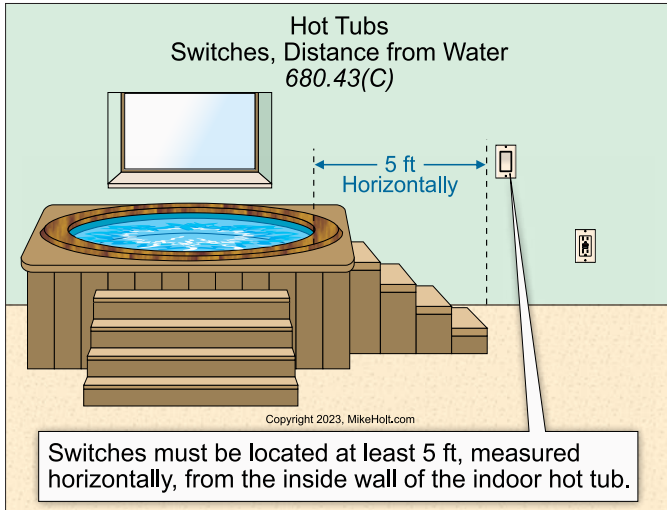

▶Figure 680-87

Author's Comment:

- ▶ A two-pole GFCI can protect a 240V hot tub that does not require a neutral. However, the GFCI requires a neutral to operate, so be sure to run a neutral to the hot tub disconnect.

(B) Listed Units. If so marked, a listed self-contained hot tub or a listed packaged equipment assembly that includes integral GFCI protection for all electrical parts, does not require additional GFCI protection. ▶Figure 680-89

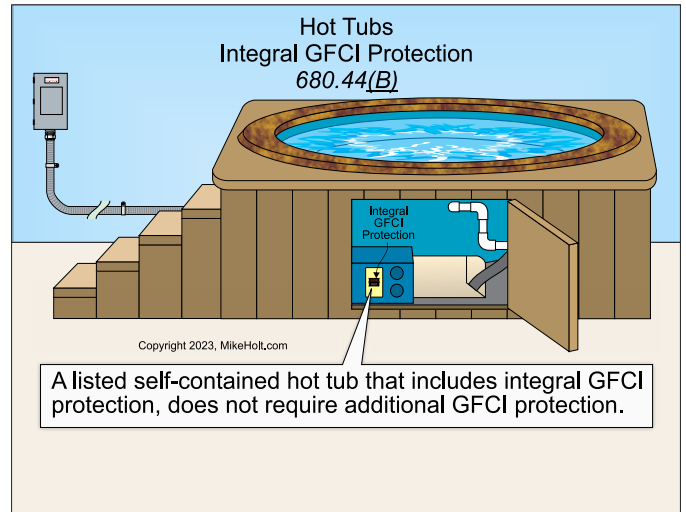

▶Figure 680-89

680.44 GFCI or SPGFCI Protection

(A) General. Hot tub assemblies must have GFCI protection in accordance with 680.5(B) or SPGFCI protection in accordance with 680.5(C). ▶Figure 680-88



▶Figure 680-88

680.45 Permanently Installed Immersion Pools

Electrical installations at permanently installed immersion pools, whether installed indoors or outdoors, must comply with Parts I, II, and IV of this article, except as modified by section 680.45 and must be connected by the wiring methods of Chapter 3 of the Code. Regarding the provisions in Part IV of this article, an immersion pool is considered a hot tub.

Part V. Fountains

680.50 General

The general installation requirements contained in Part I apply to fountains and splash pads intended for recreational use, in addition to those requirements contained in Part V. Part II of Article 680 applies to fountains that have water common to pools.

According to Article 100, a “Fountain” is defined as an ornamental structure or recreational water feature from which one or more jets or streams of water are discharged into the air including splash pads, ornamental pools, display pools, and reflection pools. This definition does not include drinking water fountains or water coolers (Article 680).

►Figure 680-90



►Figure 680-90

According to Article 100, a “Splash Pad” is defined as a fountain intended for recreational use by pedestrians with a water depth of 1 in. or less. This definition does not include showers intended for hygienic rinsing prior to use of a pool, spa, or other water feature (Article 680).

►Figure 680-91



►Figure 680-91

(A) Additional Requirements.

(2) Splash pads must have equipotential bonding in accordance with 680.26. ►Figure 680-92



►Figure 680-92

(B) Equipment Exceeding the Low-Voltage Contact Limit. Fountain equipment with ratings exceeding the low-voltage contact limit must be located at least 5 ft horizontally from the inside walls of a fountain, unless separated from the fountain by a solid fence, wall, or other permanent barrier.

680.51 Luminaires and Submersible Equipment

(A) GFCI Protection. GFCI protection is required for luminaires and submersible equipment unless listed and supplied by a swimming pool transformer in accordance with 680.23(A)(2). ►Figure 680-93



►Figure 680-93

(C) Luminaire Lenses. Luminaires must be installed so the top of the luminaire lens is below the normal water level unless listed for above-water use. ▶Figure 680-94



▶Figure 680-94

(E) Cords. The maximum length of each exposed flexible cord in a fountain is 10 ft. Power-supply cords that extend beyond the fountain perimeter must be enclosed in a wiring enclosure approved by the authority having jurisdiction.

(F) Servicing. Equipment must be capable of being removed from the water for relamping or for normal maintenance.

(G) Stability. Equipment must be inherently stable or be securely fastened in place.

680.54 Connection to an Equipment Grounding Conductor

(A) Connection to Equipment Grounding Conductor. The following must be connected to the circuit equipment grounding conductor:

- (1) Electrical equipment within the fountain or within 5 ft of the inside wall of the fountain.
- (2) Electrical equipment associated with the recirculating system of the fountain.
- (3) Panelboards that supply electrical equipment associated with the fountain.

(B) Bonding. The following parts must be bonded together with a minimum 8 AWG solid copper conductor and connected to an equipment grounding conductor for a branch circuit supplying fountain equipment:

- (1) Metal piping systems associated with the fountain
- (2) Metal fittings within or attached to the fountain
- (3) Metal parts of electrical equipment associated with the fountain water-circulating system
- (4) Metal raceways within 5 ft of the inside wall or perimeter of the fountain and not separated from it by a permanent barrier
- (5) Metal surfaces within 5 ft of the inside wall or perimeter of the fountain and not separated from it by a permanent barrier
- (6) Electrical equipment within 5 ft from the fountain's inside wall or perimeter

(C) Equipotential Bonding of Splash Pad. For equipotential bonding, the shell of a splash pad is the area where pedestrians walk, bounded by the extent of footing of the splash pad that rises to its exposed surface and its collection basin area. ▶Figure 680-95



▶Figure 680-95

680.55 Methods of Equipment Grounding

(A) Other Requirements. The requirements of 680.7(A), 680.21(A), 680.23(B)(3), 680.23(F)(1) and (2), and 680.24(F) apply to fountains.

(B) Supplied by Flexible Cord. Fountain equipment supplied by a flexible cord must have all exposed metal parts connected to an insulated copper equipment grounding conductor that is an integral part of the cord. ▶Figure 680-96



▶Figure 680-96

680.56 Cord-and-Plug-Connected Equipment

(A) GFCI Protection. All cord and plug connected equipment for fountains must be GFCI protected.

680.57 Electric Signs in or Adjacent to Fountains

Branch circuits or feeders that supply an electric sign installed within a fountain must be GFCI protected. ▶Figure 680-97



▶Figure 680-97

680.58 GFCI Protection of Receptacles

All receptacles rated 125V through 250V, 60A or less within 20 ft of the fountain's edge must have GFCI or SPGFCI protection in accordance with 680.5(B) or (C). ▶Figure 680-98

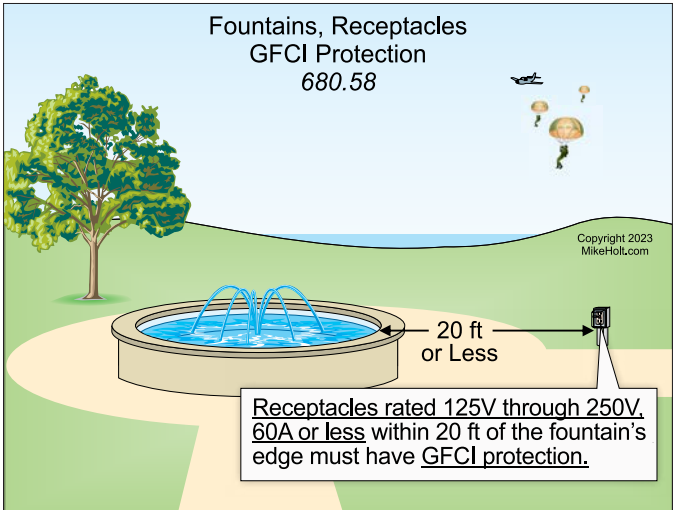

▶Figure 680-98

680.59 GFCI or SPGFCI Protection for Permanently Installed Nonsubmersible Pumps

Outlets supplying permanently installed nonsubmersible pump motors must have GFCI protection in accordance with 680.5(B) or SPGFCI protection in accordance with 680.5(C).

Part VII. Hydromassage Bathtubs

680.70 General

A hydromassage bathtub must only comply with the requirements of Part VII, it is not required to comply with the other parts of this article.

According to Article 100, a “Hydromassage Bathtub” is defined as a permanently installed bathtub with a recirculating piping system designed to accept, circulate, and discharge water after each use. ▶Figure 680-99



▶Figure 680-99

680.71 GFCI Protection

Hydromassage bathtubs and their associated electrical components must be on an individual branch circuit protected by a readily accessible GFCI device. ▶Figure 680-100

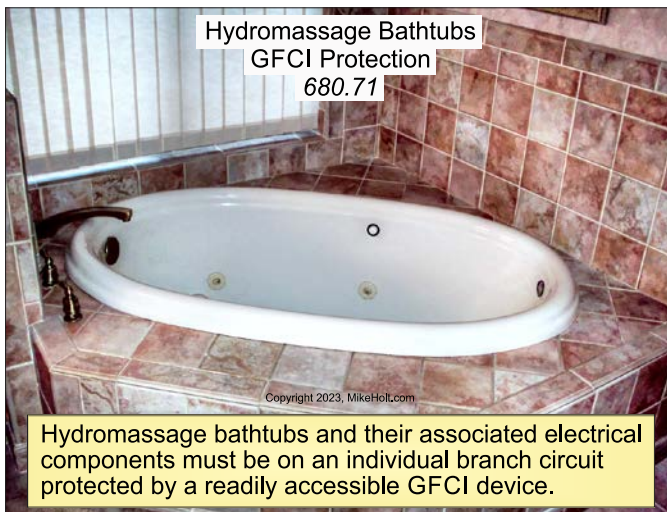

▶Figure 680-100

All 125V, single-phase receptacles not greater than 30A and within 6 ft horizontally of the inside walls of a hydromassage bathtub must be GFCI protected.

680.73 Accessibility

Electrical equipment for hydromassage bathtubs must be accessible without damaging the building structure or finish and the receptacle must be installed within 1 ft of the opening. ▶Figure 680-101



▶Figure 680-101

680.74 Equipotential Bonding

(A) General. The following parts must be bonded together.

- (1) Metal fittings within, or attached to, the hydromassage bathtub structure that are in contact with the circulating water.
- (2) Metal parts of electrical equipment associated with the hydromassage bathtub water circulating system, including pump and blower motors.
- (3) Metal-sheathed cables, metal raceways, and metal piping within 5 ft of the inside walls of the hydromassage bathtub and not separated from its area by a permanent barrier.
- (4) Exposed metal surfaces within 5 ft of the inside walls of the hydromassage bathtub and not separated from it by a permanent barrier.
- (5) Metal parts of electrical devices not associated with the hydromassage bathtub within 5 ft from the hydromassage bathtub.

Ex 1: Small conductive surfaces not likely to become energized such as air and water jets, supply valve assemblies, drain fittings not connected to metallic piping, towel bars, mirror frames, and similar nonelectrical equipment not connected to metal framing are not required to be bonded.

Ex 2: Double-insulated motors and blowers are not required to be bonded.

Ex 3: Small conductive surfaces of electrical equipment not likely to become energized, such as the mounting strap or yoke of a listed light switch or receptacle is not required to be bonded.

(B) Bonding Conductor. Metal parts required to be bonded by 680.74(A) must be bonded together using an insulated or bare solid copper conductor not smaller than 8 AWG. Bonding jumpers are not required to be extended or attached to any remote panelboard, service disconnect, or any electrode.

A bonding jumper long enough to terminate on a replacement nondouble-insulated pump or blower motor must be provided, and it must terminate to the equipment grounding conductor of the branch circuit of the motor when a double-insulated circulating pump or blower motor is used.



TAKING AN ELECTRICAL EXAM?

We can help...

Our best-selling exam preparation libraries have helped thousands of electricians across the country pass their exams.

Exam Prep libraries include:

- Theory
- Code
- Electrical Calculations
- Simulated Exams

Learn More - MikeHolt.com/ExamPrep



I thought it would be grueling studying for my exam, but after taking your courses I realized that it was uplifting and exciting.

Gary H.

LEARN THE 2023 CODE...



With one of Mike Holt's Best-Selling Code products

They take you step by step through
the National Electrical Code®

Now is the time to master the Code. Learn from NEC® Expert Mike Holt, and gain confidence when you're in the field. Choose from one of these great programs:

- Understanding the NEC® Complete Video Training Library
- Bonding and Grounding Video Program
- Changes to the 2023 NEC® Video Program
- Solar Photovoltaic and Energy Storage Systems Video Program

“You make it so easy to learn. The videos are a must, and of course the books just jump out at you. Keep up the good work.” -Mark K.



Order Today & SAVE 20%

On any Mike Holt Code Product

Use Code: PDF23

Offer expires: 12/31/2023

MikeHolt.com/Code
or Call to Order 888.632.2633